



Manual for STE2 LITE

Safety warning

The device has been tested and is in good working condition, meeting the standards required in the Czech Republic. To keep it working properly, it's important to follow the safety and maintenance guidelines listed below. If the device is used improperly, it may not work safely.

Also, make sure that the power socket or the point where the device can be unplugged from the power supply is easy to reach.

Do not use the device if:

- It looks damaged
- It's not working properly
- There are loose parts inside
- It was exposed to moisture or water for a long time
- Someone who is not authorized tried to repair it
- The power adapter or its cable looks damaged
- You're using the device in a way that's not recommended, which may compromise its safety features
- The switch, fuse, and other power surge protection features must be part of the device's overall construction.

The manufacturer is only responsible for the device if it's being powered by an approved or supplied power source.

If you experience any difficulties with installing or starting up the device, please don't hesitate to reach out to our technical support team for assistance.

HW group s.r.o.

<http://www.hw-group.com>

email: support@HWg.cz

Rumunská 26/122

Prague, 120 00

Phone: +420 222 511 918

Before contacting technical support, prepare a precise model of your device (on the manufacturing label and the firmware version (see below), if you know it.

STE2 LITE

The STE2 LITE is a thermometer that comes with Ethernet and WiFi interfaces, supports HTTPS, and can be connected to the Portal service.

The STE2 LITE is a device that can measure temperature, humidity, or other values from external sensors. It is equipped with HTTPS and SNMP features, and can be connected to a LAN or WiFi network. If the sensor value exceeds defined Safe-range, the device can send alarm messages via email. With using external SMS GW device, the SMS or Ring alerts are available. It can also be connected to the Portal (SensDesk Technology). A power adapter and temperature sensor are included in the package.



Product usage scheme

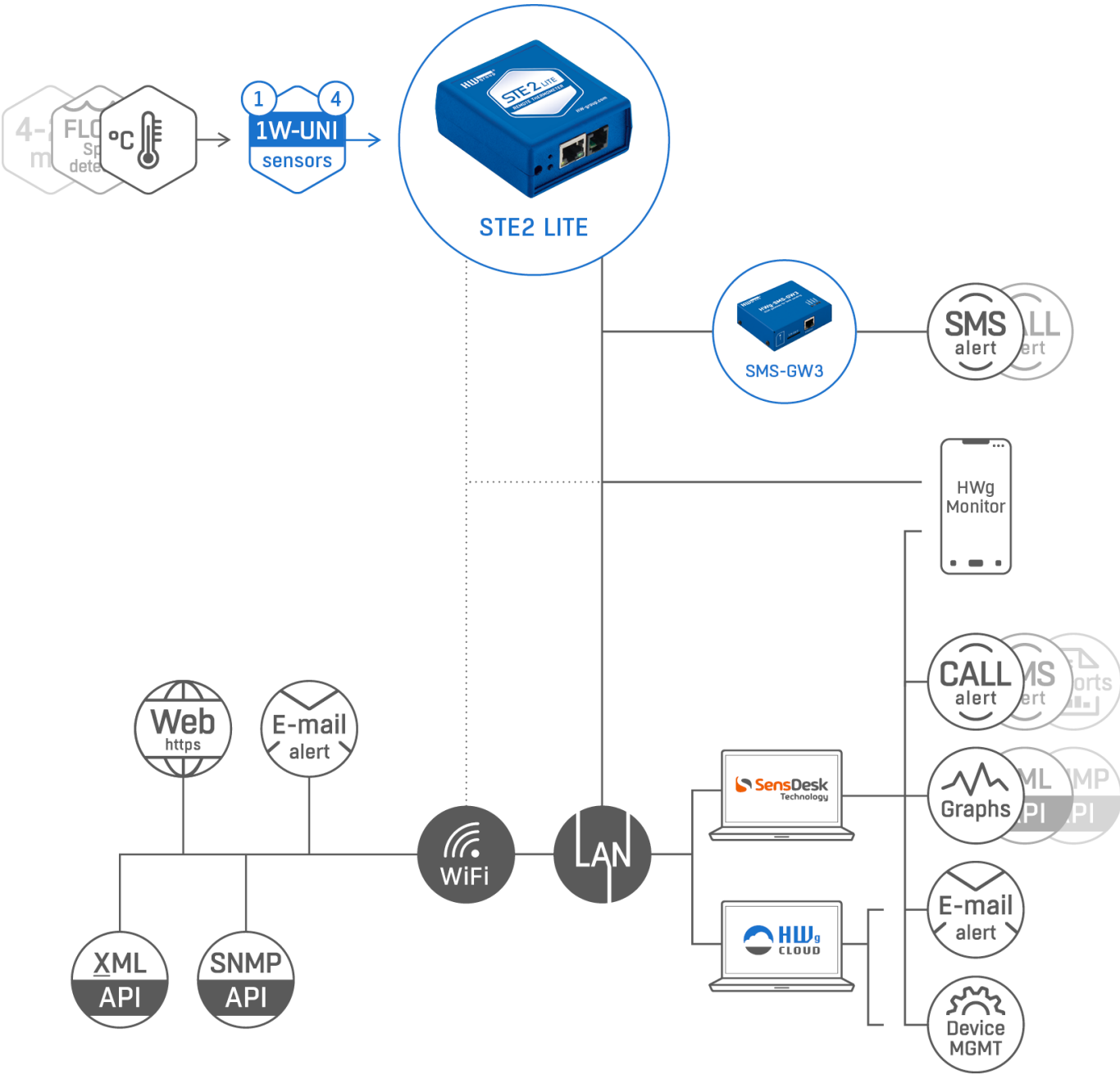

Basic features

- The device supports LAN and WiFi connections through 802.11 b/g/n (2.4 GHz).
- It supports Ethernet and WiFi operations for easy configuration.
- Device and can be powered by 5V (external power adaptor).
- The device comes with a built-in WEB server that supports HTTPS. Standard Internet browser is enough for configuration.
- Open API: It can be connected to higher-level monitoring systems via XML or SNMP.
- The device can simultaneously handle HTTP and HTTPS traffic, with the option of disabling one or both protocols for security reasons.
- If the sensor value (temperature) goes out of Safe-Range, the device can send an email as an alert.
- The device supports TLS authorization (GMAIL) and is password-protected.

Application

AC (Air Conditioning) failure

Changes in temperature alert you to outages of the A/C cooling unit..

Heating monitoring

Remote monitoring of the heating system, email or SMS alerts of freezing hazards.

Monitoring of services provided

Easily create reports with graphs of temperatures at one or more locations via Portal service. You can keep an eye on the quality of the outsourced services.

Refrigerator or freezer monitoring

Sends an email when your refrigerator fails.
Logging of operating and storage conditions.

Heating optimization

Savings on heating and air conditioning costs.

Food storage

Monitors optimal storage conditions.
HACCP protocols can be created using application software.

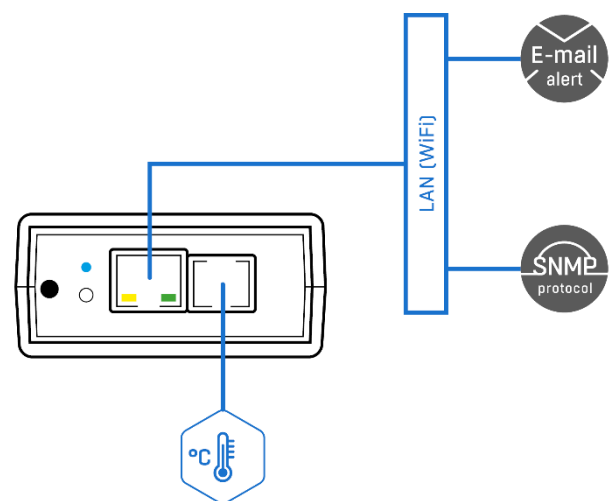

Connectors and wiring

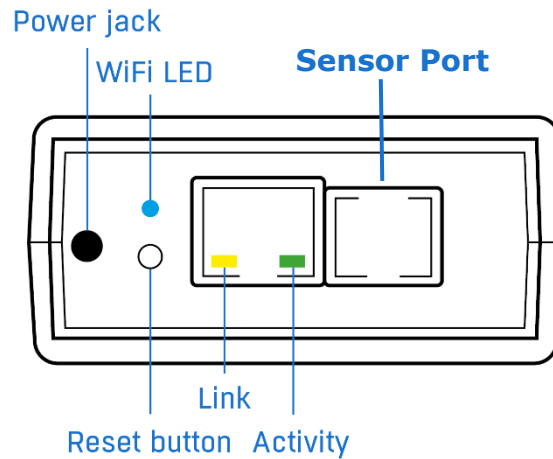

- **Ethernet** – LAN connectivity, default configuration also for WiFi connectivity.
- **Sensor Port (RJ11)** – External RJ11 sensors from HW group.
 - Each port is max 60m.
 - One physical sensor can provide several sensor values.
 - Temperature & Humidity sensor provides 2 sensor values.
- **Power** – 5V power supply (external adapter).

Indication

- **Link** – A green LED signalizes connectivity to the computer network.
- **Activity** – A yellow flashing LED signalizes ongoing communication.
- **WiFi** – A blue LED signalizes connection to the WiFi AP.

Button

- **Reset** – serves to restore factory settings on the device.
 - 1) Switch the device off.
 - 2) Press and hold the button.
 - 3) Switch the device on and press the button for another 5 seconds.
 - 4) All the LEDs will gradually light up.
 - 5) Restart the device. Factory settings will be restored.

	STE2 LITE	STE2 R2	STE2 PLUS
Ethernet	10/100Mbit	10/100Mbit	10/100Mbit
WiFi	IEEE 802.11bg	IEEE 802.11bg	IEEE 802.11bg
IPv6	-	-	YES
SNMP	v1	v1	v1 + v3
SNMP Trap	-	-	YES
DHCP	YES	YES	YES
HTTP	YES	YES	YES
HTTPS	YES	YES	YES
XML	YES	YES	YES
SMTP	YES	YES	YES
SMTP TLS	YES	YES	YES
HWg-Push (SensDesk)	YES	YES	YES
Net-GSM (SMS GW)	YES	YES	YES
Syslog	--	-	YES
Sensors			
1-Wire sensor values	Max 4	Max 5	Max 15
1-Wire UNI	YES	YES	YES
DI (Digital Inputs)	-	2	2
DO (Outputs)	-	-	8 VDO Virtual Digital Outputs
Alarms			
Email destinations	2	5	5
Trap destinations	-	5	5
SMS - destinations	2	5	5
Alarm reminder	-	-	YES
Periodical status	-	-	YES
Power and dimensions			
Power supply	5V / 300 mA	5V / 300 mA	5V / 300 mA
Connector	Jack (barrel, 1,35 / 3,5 mm)	Jack (barrel, inner 1,35 mm outer 3,5 mm)	Jack (barrel, inner 1,35 mm outer 3,5 mm)
PoE	-	YES	YES
PoE Current	-	60 mA	60 mA
PoE class	-	IEEE 802.3af Class 0	IEEE 802.3af Class 0
Operating / Storage	-30°C to 60°C 0% RH to 95% RH	-30°C to 60°C 0% RH to 95% RH	-30°C to 60°C 0% RH to 95% RH
Weight	85 g	91 g	91 g
Dimensions	68x63x32 mm	98x68x33 mm	98x68x33 mm
Environment	SoHo, IT	SoHo, IT	SoHo, IT
Installation	Table	DIN, Table, Wall	DIN, Table, Wall
Protection	IP40	IP40	IP40

Recommended connection

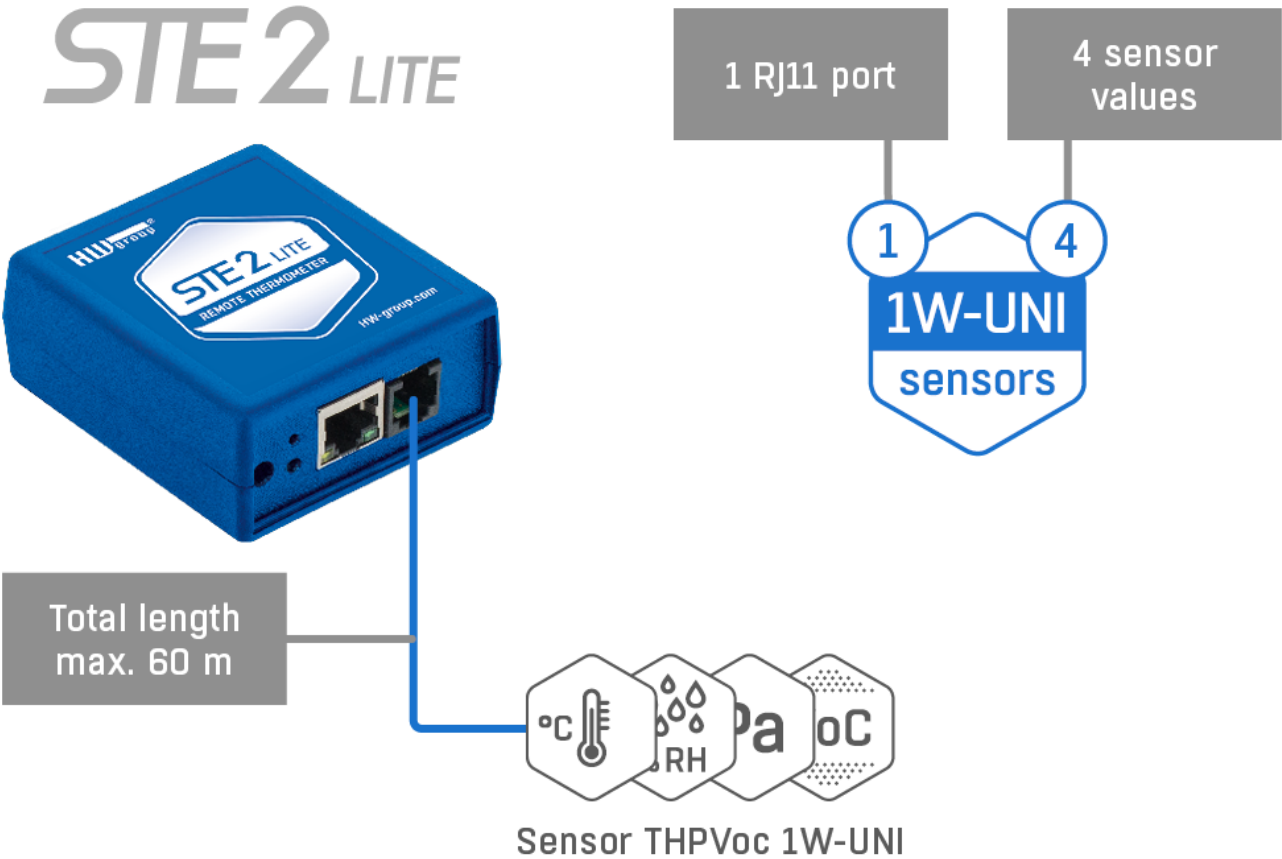

Sensor daisy-chain connection options:

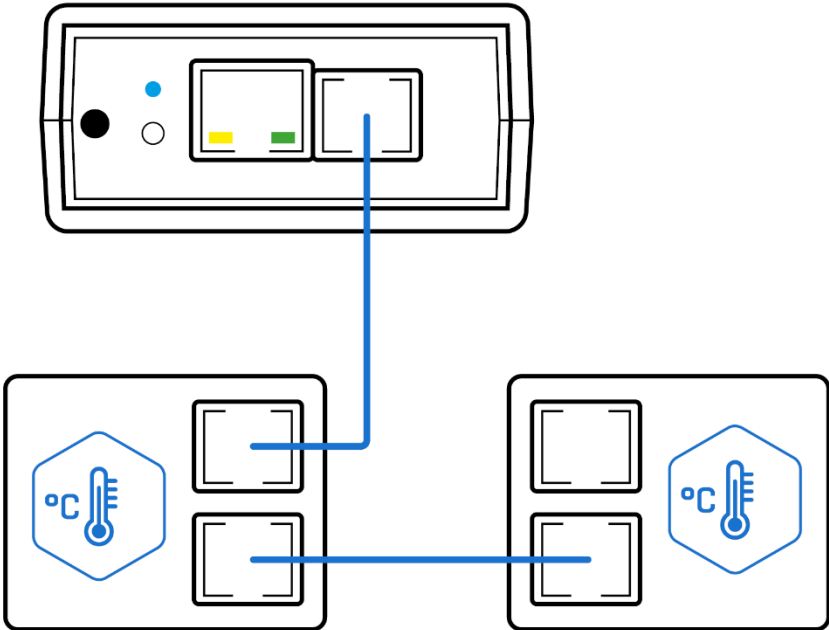

First start-up

1) Cable connection

- Connect the device to the **Ethernet** (direct cable to the switch, crossed to PC).
- Connect the power adapter to the power grid and to the device.
- If the Ethernet connection is OK, the **LINK (yellow)** light should come on a moment later. The **ACTIVITY light (green)** indicate Ethernet activity.
- The **LINK (yellow)** flashing rapidly to indicate communication with the DHCP server.

2) The setting of the IP address - HWg-Config

The **HWg-Config** program for MS Windows can be downloaded at www.hw-group.com -> [Software](#) -> [HWg-Config](#).

Launch **HWg-Config**, program automatically searches for LAN connected devices.

If device connected later, click to **Find Devices** button. Local network devices will be listed. Click on the MAC address of the device to open the dialogue window for device settings.

HWg-Config 1.2.2 for HW group products (www.hw-group.com)

Version: 1.2.2 HW group, s.r.o. www.hw-group.com
Config utility for the HW group devices

Your PC network settings
IP address: 192.168.102.1
Netmask: 255.255.252.0
Gateway: 192.168.100.1

Prefer IPv6 protocol

Device list:

MAC	Name	* IP	Device type	Port	Parameters
00:0A:59:05:20:04	SD-Water 5905-2002	192.168.103.209	SD-Water - Wifi	80	TCP setup=N, DHCP=Y
00:0A:59:04:D4:2C	TEMP-3408	192.168.103.215	HWg-STE	80	TCP setup=N, DHCP=Y
00:0A:59:05:D1:5D	JCh/ P2 3468	192.168.103.216	Poseidon2 model 3468	80	TCP setup=N, DHCP=Y
00:0A:59:05:52:43	JCh/ D2 2404	192.168.103.218	Damocles2 model 2404	80	TCP setup=N, DHCP=Y
00:0A:59:04:F5:15	JCh/ D2 1208	192.168.103.219	Damocles2 model 1208	80	TCP setup=N, DHCP=Y
00:0A:59:04:03:D8	JCh/ P2 3266 Pavel	192.168.103.220	Poseidon2 model 3266	80	TCP setup=N, DHCP=Y
00:0A:59:05:D9:E9	JCh/ STE2+ 5905-D5	192.168.103.222	STE2 PLUS - Eth	80	TCP setup=N, DHCP=Y
00:0A:59:05:B4:D3	JCh2/ WLD2 5905-B	192.168.103.224	WLD2 - Eth	80	TCP setup=N, DHCP=Y
00:0A:59:05:20:A4	JCh/ SD-1Wire 5905	192.168.103.228	SD-1Wire - Eth	80	TCP setup=N, DHCP=Y
00:0A:59:05:D5:1C	STE2 LITE 5905-D5	192.168.103.230	STE2 LITE - Eth	80	TCP setup=N, DHCP=Y
00:0A:59:05:38:0C	JCh/ HWg-STE PoE	192.168.103.231	HWg-STE	80	TCP setup=N, DHCP=Y
00:0A:59:05:D0:D3	JCh/ SD-2xIn	192.168.103.233	SD-Input - Eth	80	TCP setup=N, DHCP=Y

Searching modules... 61 device(s) found on network, 61 device(s) filtered and displayed Filter: All

Set device network parameters:

- IP address / HTTP port (80 by standard)
- Your network mask
- IP address of your network gateway
- Device name (optional parameter)

Save the settings by clicking on **Apply Changes**.

The screenshot shows a 'Details' configuration window for the STE2 LITE device. The window contains the following fields and options:

- Name:** STE2 LITE 5905-D51C
- IP address:** 192.168.103.23((DHCP))
- Port:** 80
- Open in WEB browser:** Button with a globe icon.
- Enable DHCP:** Enable DHCP
- IPv6:**
 - Link local address: Not supported
 - Address/prefix: Not supported
- Mask:** 255.255.252.0 (DHCP)
- Gateway:** 192.168.100.1 (DHCP)
- Enable IP access filter:** Enable IP access filter
- IP filter value:** 0.0.0.0
- IP filter mask:** 0.0.0.0
- Default values:**
 - Load defaults: Button with a pencil icon.
- MAC:** 00:0A:59:05:D5:1C
- FW version:** 1.5.1
- Device type:** STE2 LITE - Eth (102)
- DHCP:** Supported
- Enable NVT:** Enable NVT
- Enable TCP setup:** Enable TCP setup
- Enable TEA authorisation:** Enable TEA authorisation
- Check if new IP address is empty:** Check if new IP address is empty
- Buttons:** Cancel (with a red 'X' over it), Apply changes (with a refresh icon), and Open.

The status bar at the bottom of the window shows 'Ready'.

2 options how to restore device default settings:

- 1) Right-click on the device's MAC address. Click to **Load default values** item.
Note: Device default values can be restored from the HWg-Config program only during first 60 settings after device powered-up.
- 2) Switch off the device. Press the **RESET** button on the device, **hold it down and connect the device** power source (power adaptor). Hold the button down for another 5 seconds until all the LEDs light up.

3) How to open the device website

- 1) Enter the device IP address in your web browser if you know it.
- 2) Use right-click on device in the HWg-Config program. Select **Open in WEB Browser**.
- 3) Click on the underlined IP address in the HWg-Config program.

HWg-Config 1.2.2 for HW group products (www.hw-group.com)

Version: 1.2.2 HW group, s.r.o. www.hw-group.com
Config utility for the HW group devices

Your PC network settings
IP address: 192.168.102.1
Netmask: 255.255.252.0
Gateway: 192.168.100.1

Find Devices

Device list:

MAC	Name	* IP	Device type	Port	Parameters
00:0A:59:05:D1:5D	JCh/ P2 3468	192.168.103.216	Poseidon2 model 3468	80	TCP setup=N, DHCP=Y
00:0A:59:05:52:43	JCh/ D2 2404	192.168.103.218	Damocles2 model 2404	80	TCP setup=N, DHCP=Y
00:0A:59:04:F5:15	JCh/ D2 1208	192.168.103.219	Damocles2 model 1208	80	TCP setup=N, DHCP=Y
00:0A:59:04:03:D8	JCh/ P2 3266 Pavel	192.168.103.220	Poseidon2 model 3266	80	TCP setup=N, DHCP=Y
00:0A:59:05:D9:E9	JCh/ STE2+ 5905-D5	192.168.103.222	STE2 PLUS - Eth	80	TCP setup=N, DHCP=Y
00:0A:59:05:B4:D3	JCh2/ WLD2 5905-B	192.168.103.224	WLD2 - Eth	80	TCP setup=N, DHCP=Y
00:0A:59:05:20:A4	JCh/ SD-1Wire 5905	192.168.103.228	SD-1Wire - Eth	80	TCP setup=N, DHCP=Y
00:0A:59:05:D5:1C	STE2 LITE 5905-D5	192.168.103.230	STE2 LITE - Eth	80	TCP setup=N, DHCP=Y
00:0A:59:05:38:0C	JCh/ HWg-STE PoE	192.168.103.231	HWg-STE		
00:0A:59:05:D0:D3	JCh/ SD-2xIn	192.168.103.233	SD-Input - Eth		
00:0A:59:05:D3:52	STE2 PLUS 5905-D3	192.168.103.246	STE2 PLUS -		
00:0A:59:04:86:F4	JCh/ P2 3266	192.168.103.251	Poseidon2 mo		

Searching modules... 57 device(s) found on network, 57 device(s) filtered

Context menu for selected device:

- Show detail settings of device...
- Open in WEB Browser (port 80)
- Open TCP Setup (port 99)
- Download device configuration...
- Upload device configuration...
- Load default values
- Export Devices...

WWW interface

Home tab

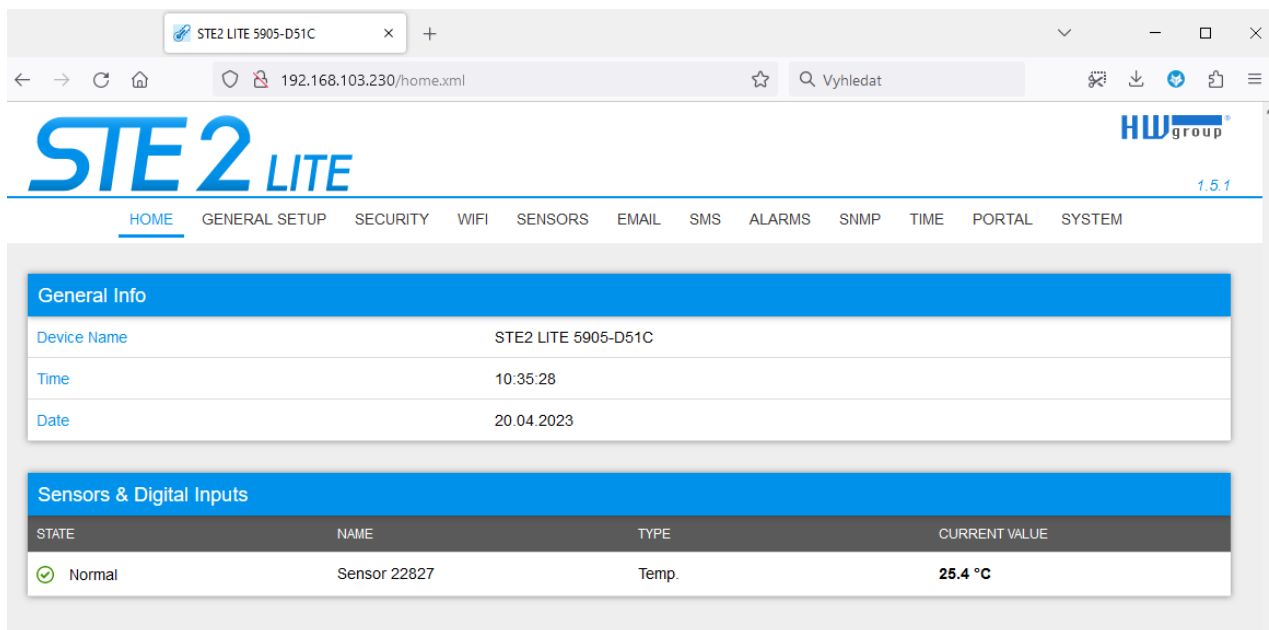

General Info section

- **Device Name:** This setting allows you to assign a unique name to the device, which can be helpful when managing larger installations. You can configure the device name on the General Setup tab.
- **Time:** This displays the current time of the device. You can set it manually on the Time tab, or you can choose to synchronize it automatically with the Internet. If the automatic synchronization is successful, the displayed time indicates that the device has Internet access.
- **Date:** This shows the current date of the device. You can set it manually on the Time tab, or you can synchronize it automatically with the Internet. If the automatic synchronization is successful, the displayed date indicates that the device has Internet access.

Sensors & Digital Inputs section

- **State** – Current state of the input or sensor.
 - **Normal** - Quiet state, everything is fine.
 - **Alarm High** - The value has exceeded the upper allowable limit.
 - **Alarm Low** - The value has dropped below the lower allowable limit.
- **Name** - The name of the sensor used for better identification in larger systems. The name can be set on the Sensors page.
- **Type** - Sensor Type; determines what type of sensor it is (temperature/humidity/digital input, etc.).
- **Current Value** - The current value including measured quantity.

General Setup tab

STE2 LITE 5905-D51C

192.168.103.230/general_setup.xml

Vyhledat

STE2 LITE HWgroup 1.5.1

HOME **GENERAL SETUP** SECURITY WIFI SENSORS EMAIL SMS ALARMS SNMP TIME PORTAL SYSTEM

General

NAME	VALUE	DESCRIPTION
Device Name	<input type="text" value="STE2 LITE 5905-D51C"/>	0 to 32 characters
WWW Info Text:	<input http:="" type="text" value="STE2 LITE: For more information visit www.hw-group.com"/>	
Temperature unit	<input type="text" value="Celsius"/>	Celsius/Fahrenheit/Kelvin
WWW Update period:	<input type="text" value="1"/>	[s] Automatic update period in seconds. 0=> disabled
Periodic restart	<input type="text" value="Off"/>	Periodic restart time
HTTP Port	<input type="text" value="80"/>	Default 80
HTTPS Port	<input type="text" value="443"/>	Default 443. See https settings at Security page
LED disable	<input checked="" type="checkbox"/>	Disable device LEDs (not in Ethernet RJ-45 connector)

Network IPv4

NAME	VALUE	DESCRIPTION
DHCP	<input checked="" type="checkbox"/>	DHCP Enable/Disable
IP Address	<input type="text" value="192.168.103.230"/>	A.B.C.D
Network Mask	<input type="text" value="255.255.252.0"/>	A.B.C.D
Gateway	<input type="text" value="192.168.100.1"/>	A.B.C.D
DNS Primary	<input type="text" value="192.168.100.237"/>	A.B.C.D
DNS Secondary	<input type="text" value="192.168.100.28"/>	A.B.C.D

Device Admin

NAME	VALUE	DESCRIPTION
Username	<input type="text"/>	Admin username/password for device configuration changes [0 to 16 characters]
Password	<input type="text"/>	

General part

- **Device Name** - The device name (default "STE2 PLUS") helps to differentiate individual devices in the network.
- **WWW Info Text** - Text displayed in the footer of the device's web page.
- **Temperature Unit** - Allows selecting the unit to display temperature - Celsius, Fahrenheit or Kelvin. The Safe-Range values are automatically calculated based on this option.
- **Periodic Restart** - A feature that enables periodic automatic restart of the device to improve its stability in exposed networks.
- **Disable LEDs** - Allows disabling certain signaling LEDs on the device, except for those on the RJ45 connector.
- **HTTP Port** - The port number on which the embedded WWW server listens, which can be changed for accessing multiple devices from an external network through a router. The default port is 80, and setting the value to 0 disables HTTP support.
- **HTTPS Port** - The port number on which the embedded WWW server listens for secure HTTPS connections, which can be changed for accessing multiple devices from an external network through a router. The default port is 443, and setting the value to 0 disables HTTPS support. It's essential to verify any changes with the network administrator.

Network IPv4 section

The IPv4 parameters of the RJ45 connection. WiFi parameters connection are in the WiFi tab.

- **DHCP** - Enables the IP address setting function of the DHCP server, if available. Enabling or disabling DHCP depends on the needs of the user and the network administrator.
- **IP Address** - The IP address of the device, assigned by the network administrator.
- **Network Mask** - Network mask, assigned by the network administrator.
- **Gateway** - IP address of the default gateway, assigned by the network administrator.
- **DNS Primary / DNS Secondary** - IP address of the DNS server, assigned by the network administrator.

Device Admin section

- **Username / Password** - The username and password used to secure access to the web device environment.

Security tab

The screenshot shows the STE2 LITE web interface at the URL 192.168.103.230/security.xml. The page title is "HTTPS Server Certificate files". It displays three certificate entries, each with a description, filename, and options to import or delete the file. The entries are:

TYPE:	SSLCERTIFICATEFILE
Description:	Public key certificate file, ext. *.crt
Filename:	cert.crt
Import file:	Procházet... Soubor nevybrán. Upload
Edit File:	Delete File
TYPE:	SSLCERTIFICATEKEYFILE
Description:	Secret key file, ext. *.key
Filename:	key.pem
Import file:	Procházet... Soubor nevybrán. Upload
Edit File:	Delete File
TYPE:	SSLCACERTIFICATEFILE
Description:	CA certificate file, ext. *.pem
Filename:	*.pem
Import file:	Procházet... Soubor nevybrán. Upload
Edit File:	Delete File

Below the entries, there is a "Generate:" section with a warning: "Generate a private SSL key and selfsigned certificate for closed networks or testing purposes. The generated certificate is selfsigned and will be displayed as untrusted. Please add the certificate to the list of exceptions or use a certificate signed by a trusted certification authority. Please note that the generated data will replace the SSLCertificateFile and the SSLCertificateKeyFile. Generating the key can take up to 10minutes. Do not restart the device and do not search for sensors. Otherwise the key generation will be interrupted." A button labeled "Generate the SSL key and certificate" is located at the bottom of this section.

HTTPS Server Certificate files

Used to manage certificates needed for the HTTPS server. Allows you to upload or delete a public key, a private key, or a certificate of the certificate authority (CA) that has issued the public key certificate.

Generate the SSL key and certificate

Generate a private SSL key and self-signed certificate for closed networks or testing purposes. The generated certificate is self-signed and will be displayed as untrusted.

Please add the certificate to the list of exceptions or use a certificate signed by a trusted certification authority. Please note that the generated data will replace the SSL Certificate File and the SSL Certificate Key File.

Generating the key can take up few minutes. Do not restart the device and do not search for sensors. Otherwise, the key generation will be interrupted.

WiFi tab

When WiFi is off, only the enable option is shown:

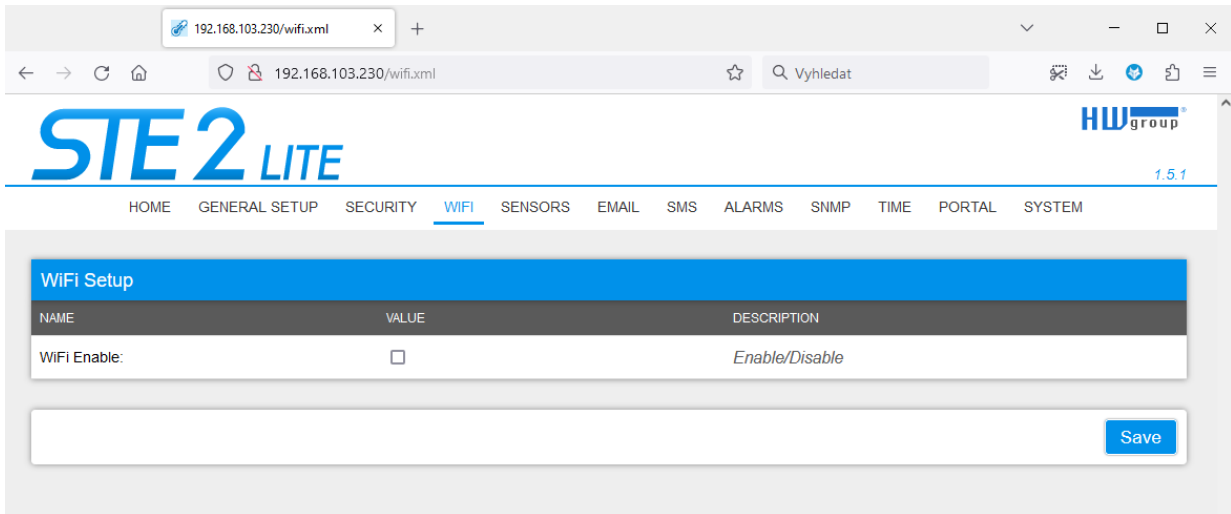

The screenshot shows the STE2 LITE web interface at the URL 192.168.103.230/wifi.xml. The 'WiFi' tab is selected in the navigation menu. The 'WiFi Setup' section contains a table with the following data:

NAME	VALUE	DESCRIPTION
WiFi Enable:	<input type="checkbox"/>	Enable/Disable

A 'Save' button is located at the bottom right of the form.

All the options are available after enabling:

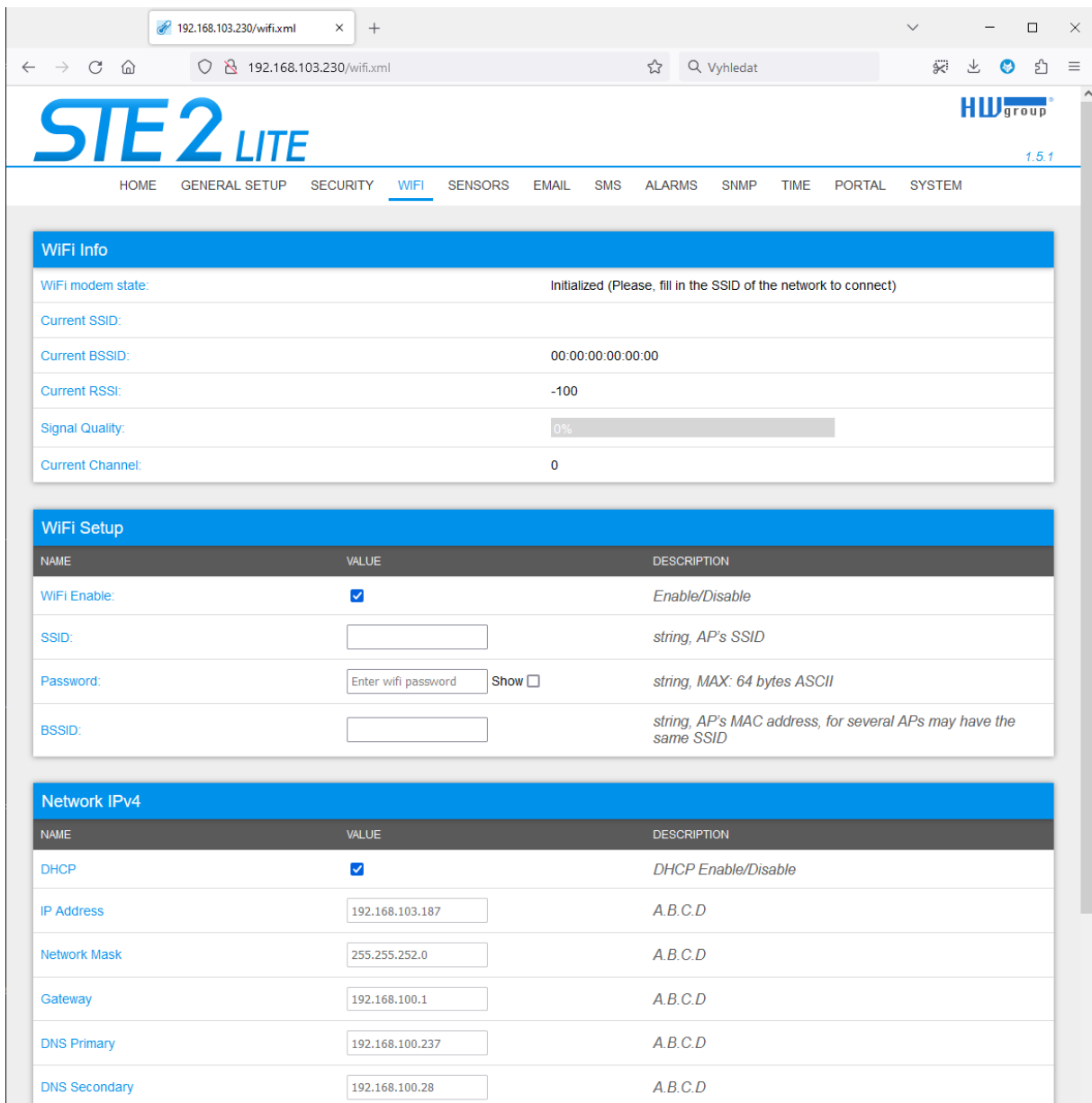

The screenshot shows the STE2 LITE web interface at the URL 192.168.103.230/wifi.xml. The 'WiFi' tab is selected. The 'WiFi Info' section displays the following information:

WiFi modem state:	Initialized (Please, fill in the SSID of the network to connect)
Current SSID:	
Current BSSID:	00:00:00:00:00:00
Current RSSI:	-100
Signal Quality:	0%
Current Channel:	0

The 'WiFi Setup' section contains a table with the following data:

NAME	VALUE	DESCRIPTION
WiFi Enable:	<input checked="" type="checkbox"/>	Enable/Disable
SSID:	<input type="text"/>	string, AP's SSID
Password:	<input type="text" value="Enter wifi password"/> Show <input type="checkbox"/>	string, MAX: 64 bytes ASCII
BSSID:	<input type="text"/>	string, AP's MAC address, for several APs may have the same SSID

The 'Network IPv4' section contains a table with the following data:

NAME	VALUE	DESCRIPTION
DHCP	<input checked="" type="checkbox"/>	DHCP Enable/Disable
IP Address	<input type="text" value="192.168.103.187"/>	A.B.C.D
Network Mask	<input type="text" value="255.255.252.0"/>	A.B.C.D
Gateway	<input type="text" value="192.168.100.1"/>	A.B.C.D
DNS Primary	<input type="text" value="192.168.100.237"/>	A.B.C.D
DNS Secondary	<input type="text" value="192.168.100.28"/>	A.B.C.D

WiFi Info section

- **WiFi modem state**
 - **Disable** – Wifi is disabled.
 - **Wait for power on** – Waits for WiFi module when power on.
 - **Init** – Initializing of WiFi module.
 - **Connecting** – Connecting.
 - **SSID check** – SSID check.
 - **Connected** – Connected to selected WiFi network.
 - **Network WiFi scan** – Scan of available WiFi networks.
 - **Wait for scan** – Waits for Network WiFi scan.
- **Current SSID** – Current name of the network to which the device is connected. If the parameter is missing, the device is not connected to any WiFi network.
- **Current BSSID** – Current identifier of the WiFi network connection point. If the parameter is missing, the device is not connected to any WiFi network.
- **Current RSSI** – Relative strength of signal input. The higher the RSSI, the stronger the signal.
- **Signal Quality** – Strength of WiFi signal in % with graphic indicator.
- **Current Channel** – WiFi channel on which the device communicates. If the parameter is missing, the device is not connected to any WiFi network.

WiFi Setup section

- **WiFi Enable** – Enable or disable WiFi. By standard, the wireless interface is disabled. Device restart follows enabling.
- **SSID** – Name of the WiFi network to which should be the device connected. If you do not know your network name, use the Scan AP function at the bottom of the page.
- **Password** – Secured network password. If you do not know it, contact your network administrator.
- **BSSID** – Identifier of the WiFi network connection point (MAC address of the connection point). Optional data.

Network IPv4 section

WiFi network parameters. Only the wireless interface is set here. Configure RJ45 LAN parameters on the General Setup tab.

- **DHCP** - Enables the IP address setting function of the DHCP server, if available. Enabling or disabling DHCP depends on the needs of the user and the network administrator.
- **IP Address** - The IP address of the device, assigned by the network administrator.
- **Network Mask** - Network mask, assigned by the network administrator.
- **Gateway** - IP address of the default gateway, assigned by the network administrator.
- **DNS Primary / DNS Secondary** - IP address of the DNS server, assigned by the network administrator.

Wifi Scan List section

- **SSID** - Name of the WiFi network found.
- **BSSID** - Connection point identifier (MAC address).
- **Channel** - The WiFi channel on which the mount point is communicating.
- **Security** - The security type of WiFi communication.
- **Signal** - WiFi signal strength in % with graphical indicator.

Connecting to a WiFi found

- Click on the SSID of the found network to pre-fill the WiFi settings and just fill in the Password. The BSSID field will remain blank. Standard settings. When you change the AP, it will reconnect itself.
- Clicking on the BSSID will pre-fill not only the network name (SSID) but also the MAC address of the specific AP (BSSID) the device will then connect to that AP and in the case of pooled networks will not try to reconnect.

Scan AP

Wifi Scan List				
SSID	BSSID	CHANNEL	SECURITY	SIGNAL
HWghost	D6:21:F9:5E:AB:02	1	WPA2 PSK	88%
Poseidon	D0:21:F9:5E:AB:02	1	WPA2 PSK	86%
PosDam	DA:21:F9:5E:AB:02	1	OPEN	86%
PosDam	7A:45:58:A5:E9:1C	6	OPEN	82%
HWghost	7A:45:58:95:E9:1C	6	WPA2 PSK	80%
Poseidon	78:45:58:D5:E9:1C	6	WPA2 PSK	80%
Poseidon	FC:EC:DA:3B:ED:55	6	WPA2 PSK	60%
HWghost	02:EC:DA:3B:ED:55	6	WPA2 PSK	60%
PosDam	06:EC:DA:3B:ED:55	6	OPEN	60%
Testovna	00:04:56:A0:94:D0	11	WPA2 PSK	50%
linksys	00:25:9C:FD:E6:71	1	OPEN	40%
PosDam	06:EC:DA:3E:39:E6	1	OPEN	40%
DIRECT-2D-HP Laser 135w	B2:22:7A:56:CE:2D	1	WPA2 PSK	38%
PosDam	06:EC:DA:3E:38:12	1	OPEN	32%
Poseidon	FC:EC:DA:3E:38:12	1	WPA2 PSK	30%
ASUS	40:3F:8C:CB:84:FE	9	WPA2 PSK	30%
HWghost	7A:45:58:95:FA:54	11	WPA2 PSK	30%
Poseidon	78:45:58:D5:FA:54	11	WPA2 PSK	30%
PosDam	7A:45:58:A5:FA:54	11	OPEN	30%
STATUS24	60:A4:4C:66:6A:3B	2	WPA2 PSK	26%

Sensor tab

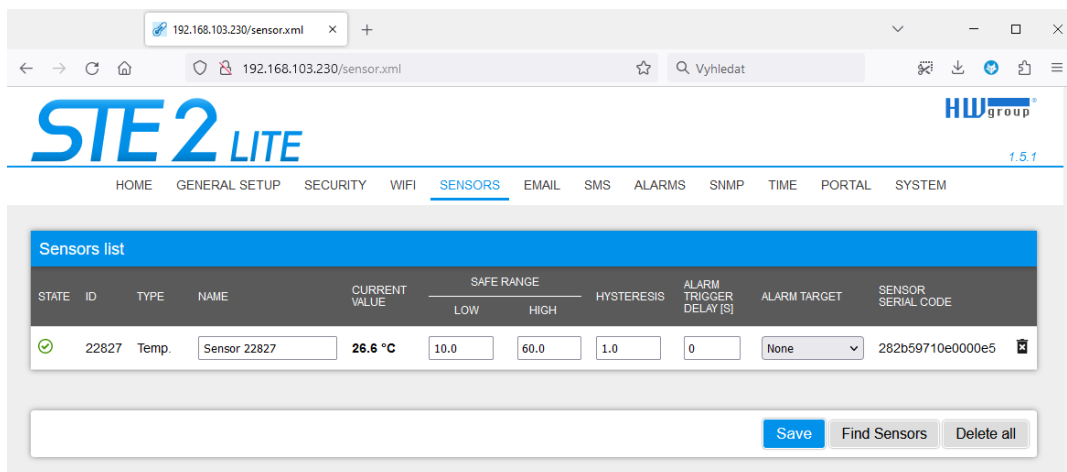

Sensor List Section*

- **State** - State of the DI (input) or sensor.
 - 🟢 **Normal** - Quiet state, everything is fine.
 - 🚨 **Alarm High** - The value has exceeded the upper allowable limit.
 - 🚨 **Alarm Low** - The value has fallen below the lower allowable limit.
- **ID** - 2 bytes sensor ID (identical to ID on Poseidon2 devices).
- **Type** - Sensor type; indicates what type of sensor it is (temperature/humidity etc.).
- **Name** - The name of the sensor, used for better identification in larger systems. It can be set on the Sensor or Digital Input tab.
- **Current Value** - The current value including the measured quantity.
- **Safe Range** - This refers to the range of acceptable (allowed) values that are considered within normal limits. If the current value falls outside the Safe Range, an alarm is triggered to indicate that the measurement is out of bounds and requires attention.
- **Hysteresis** - This parameter specifies a range of insensitivity when the measured value crosses the limit value. It prevents triggering of multiple alarms when the value oscillates around the limit. For more details, please refer to page 40 of the manual.
- **Alarm Target** - Allows you to define targets where Alarm messages (SMS + Email) will be sent. Target destinations are set on the Alarms page. The drop-down menu allows you to assign an existing set of targets to the sensor or create a new one.
- **Alarm Trigger Delay [s]** - Delays the sending of alarm start information by a defined time.
- **Sensor Serial Code** - The full ID of the 1-Wire sensor.
- 🗑️ **Delete** - The button to delete a specific sensor.

Sensor alarm state indication

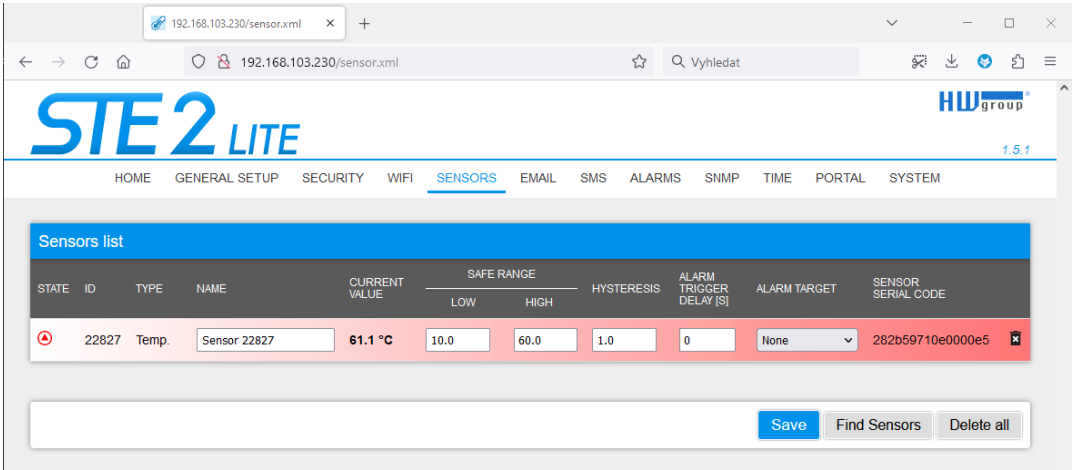

* Sensor that is in Alarm state is highlighted.

Hysteresis

The Hysteresis value defines the width of the tolerance range for sending an alarm. This function stops multiple alarms from happening when the value goes up and down around a set point. You can see this on the graph.

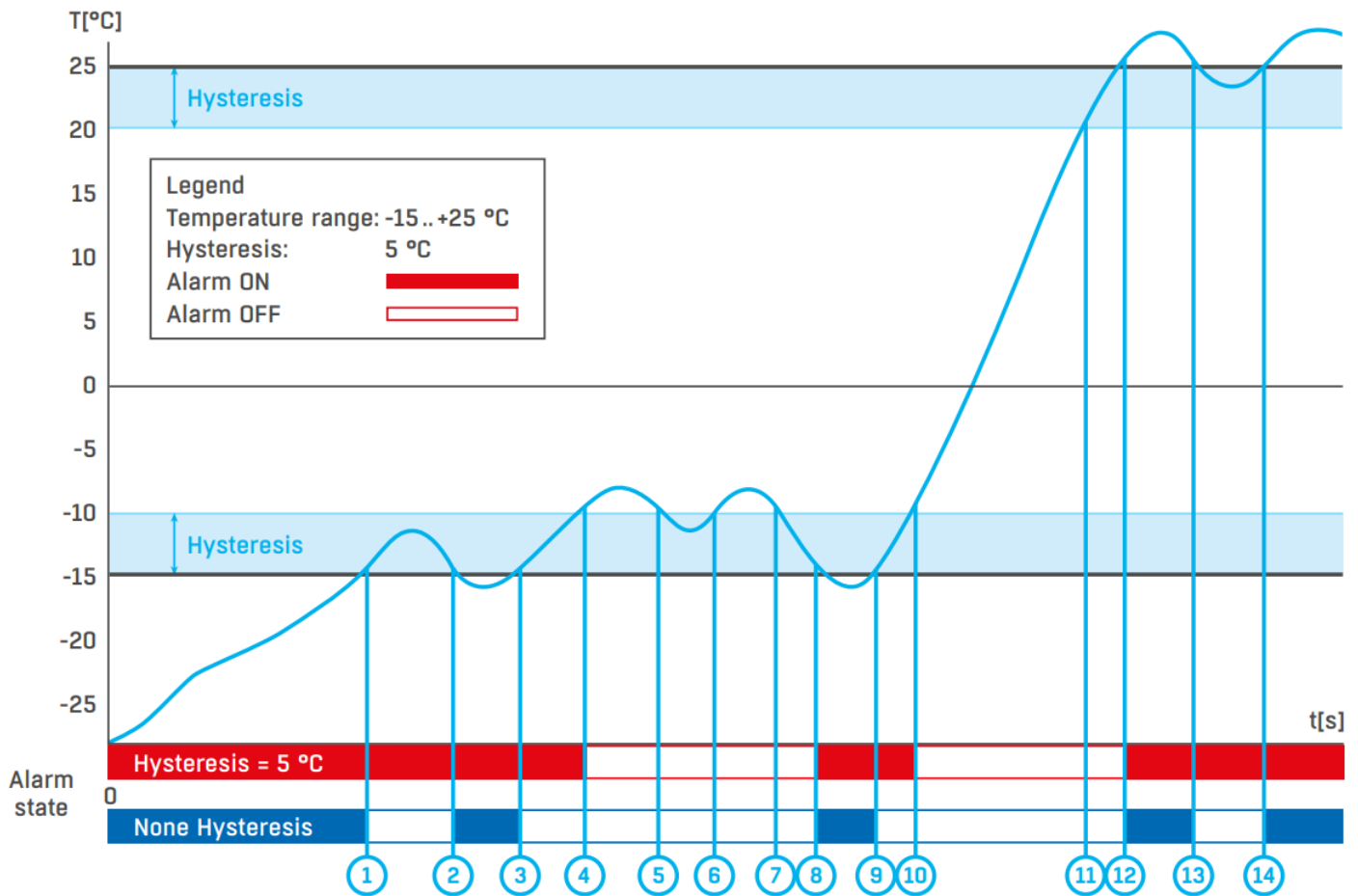

Within the internal 5°C hysteresis band, the alarm would be activated at **point 8** and would end at **point 9**. Because of the hysteresis function, the alarm is extended until the temperature reaches the end of the hysteresis zone (point 10) $5\text{ °C} + (-15\text{ °C}) = -10\text{ °C}$.

- Hysteresis (=5 °C):** The unit sends **3** alerts (email, SMS, ...) Alarm at points **0-4, 8-10, 12** and upwards.
- Without hysteresis (0 °C):** The unit sends **8** alerts (email, SMS, ...) Alarm at points **0-1, 2-3, 8-9, 12-13, 14** and upwards.

Email tab

The screenshot shows the STE2 LITE web interface. The top navigation bar includes: HOME, GENERAL SETUP, SECURITY, WIFI, SENSORS, EMAIL (selected), SMS, ALARMS, SNMP, TIME, PORTAL, SYSTEM. The version number 1.5.1 is displayed in the top right.

Email Settings

NAME	VALUE	DESCRIPTION
SMTP Server	<input type="text" value="some.smtp.server"/>	IP Address or DNS Name
SMTP Port	<input type="text" value="25"/>	Default 25
Authentication	<input type="checkbox"/>	Enable/Disable
Secure TLS mode	<input type="checkbox"/>	Enable/Disable
Use HTML formatting	<input type="checkbox"/>	Uses html to format email message body.
Username	<input type="text"/>	0 to 128 characters
Password	<input type="text"/>	0 to 128 characters
Importance	<input type="text" value="Normal"/>	Email importance flag
From	<input type="text" value="user@domain.com"/>	Device email address
Subject	<input type="text" value="subject"/>	Beginning of email subject

Email Test Log

Email address	<input type="text" value="recipient@domain.com"/>	Email for testing
<div style="border: 1px solid #ccc; height: 100px; width: 100%;"></div>		Debug log window

Email Settings

- **SMTP Server** – IP address or domain address of the SMTP server.

Note: Consider long-term stability of used SMTP server. If the service provider change security requirements (separated username or password for example) your device alerting functionality will be lost without any warning. Consider using the Portal (SensDesk Technology) alerting services.

- **SMTP Port** – Port number on which the email server tunes in – 25 by the standard.
- **Authentication** – Enable authentication; check if the SMTP server requires authentication.
- **Secure TLS mode** – Check if the SMTP server requires secure communication via SSL/TLS.
- **Username** – Username for SMTP server authentication. If the Authentication field is not checked, the content of this field is irrelevant.

- **Password** – Password for SMTP server authentication. If the Authentication field is not checked, the content of this field is irrelevant.
- **Importance** – Sets the priority of the email message. Important for filtering and further processing alarm messages.
- **FROM** – Sender's email address, i.e. of the device. The address may be required by the SMTP servers and can be used to identify the device or to filter and further process alarm messages.
- **Subject of email** – The field content can be used to identify the device or for filtering and further processing of alarm messages.

Email Test Log section

In this section, the SMTP server settings can be tested. Click Test Email to send a test email to the specified Email address. The Debug log window shows the communication with the SMTP server.

SMS tab

This functionality requires HWg-SMS device with active sim-card available on the network.

192.168.103.230/sms.xml

192.168.103.230/sms.xml

Vyhledat

STE2 LITE HWgroup 1.5.1

HOME GENERAL SETUP SECURITY WIFI SENSORS EMAIL **SMS** ALARMS SNMP TIME PORTAL SYSTEM

Remote SMS gateway

NAME	VALUE	DESCRIPTION
Enable	<input checked="" type="checkbox"/>	Enable/Disable
SMS Gateway Address	<input type="text"/>	IP Address or DNS Name
Port	80	Default 80
Username	<input type="text"/>	
Password	<input type="text"/>	

Save

SMS Test Log

Phone number Phone number for testing

Debug log window.

Test SMS Test Call

Remote SMS gateway

- **Enable** – Turns on the SMS sending function.
For sending alert, the SMS alarm action must be configured at the sensor or DI settings.
- **SMS Gateway Address** – IP address where “HWg-SMS-GW” device is located. It can be set including service - typically /service.xml (for example “<http://192.168.15.1/service.xml>”)
- **Port** – The TCP port on which the gateway listens.
- **Username** – User name for authorization in SMS GW.
- **Password** – Password for authorization in SMS GW.
- **SMS + Ring When Alarm** – Enables sending an SMS and then dialing the number.

SMS Test Log

In this section, the SMS gateway settings can be tested.

- **Test SMS** – Sends a test text message to the specified Phone number.
- **Test Call** – Dials the specified Phone number.
- **Debug log window** – This shows the communication with the SMS gateway.

Alarms tab

This tab is used to set alarm targets. Up to 3 sets of destinations can be created and each set can contain up to 5 email destinations and 5 phone number destinations for SMS and voice call alarms.

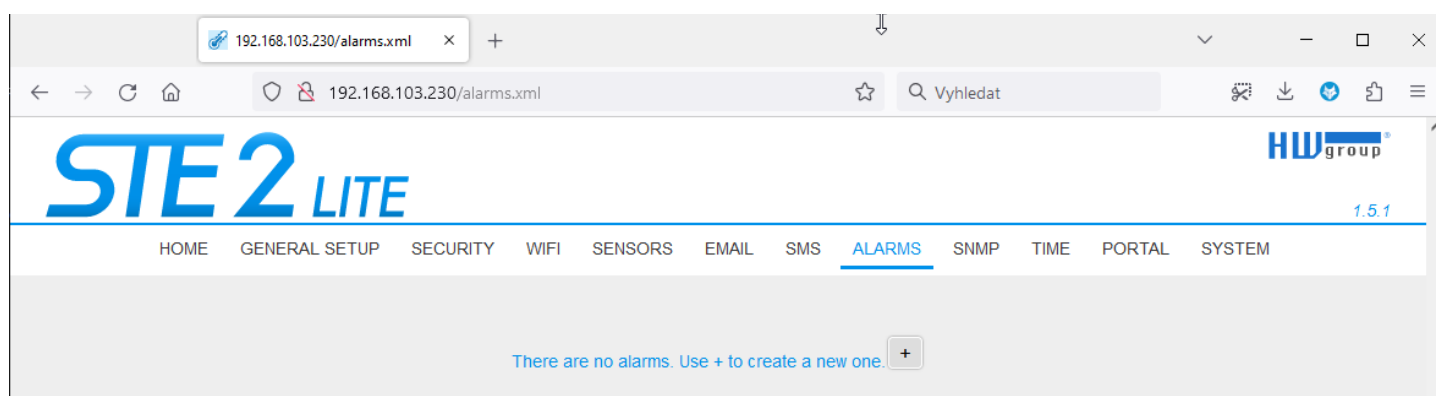

These sets are then assigned to individual sensors and Digital Inputs. The set is created either by pressing the + button on the Alarms page or by selecting **Add new...** on the Sensor or Digital Input edit page.

Alarm Target

A set of targets. The set can be named for better clarity.

- **Email list** - A set of email addresses to which alarm messages will be sent. The SMTP server on the Email tab must be set up correctly for the email to be sent.
 - **Email address** - The field can only contain one email address at a time.
- **SMS list** - A set of phone numbers to which alarm messages will be sent. To send SMS, the SMS gateway must be set up correctly on the SMS tab.
 - **Phone number** - The field may only contain one phone number at a time.
 - **Call** - If checked, the phone number will still ring after the SMS is sent (the user does not need to hear the incoming SMS). The ringing lasts for 20 seconds for each individual number and then it is terminated. Receiving a call only ends the ringing, no voice message is sent.

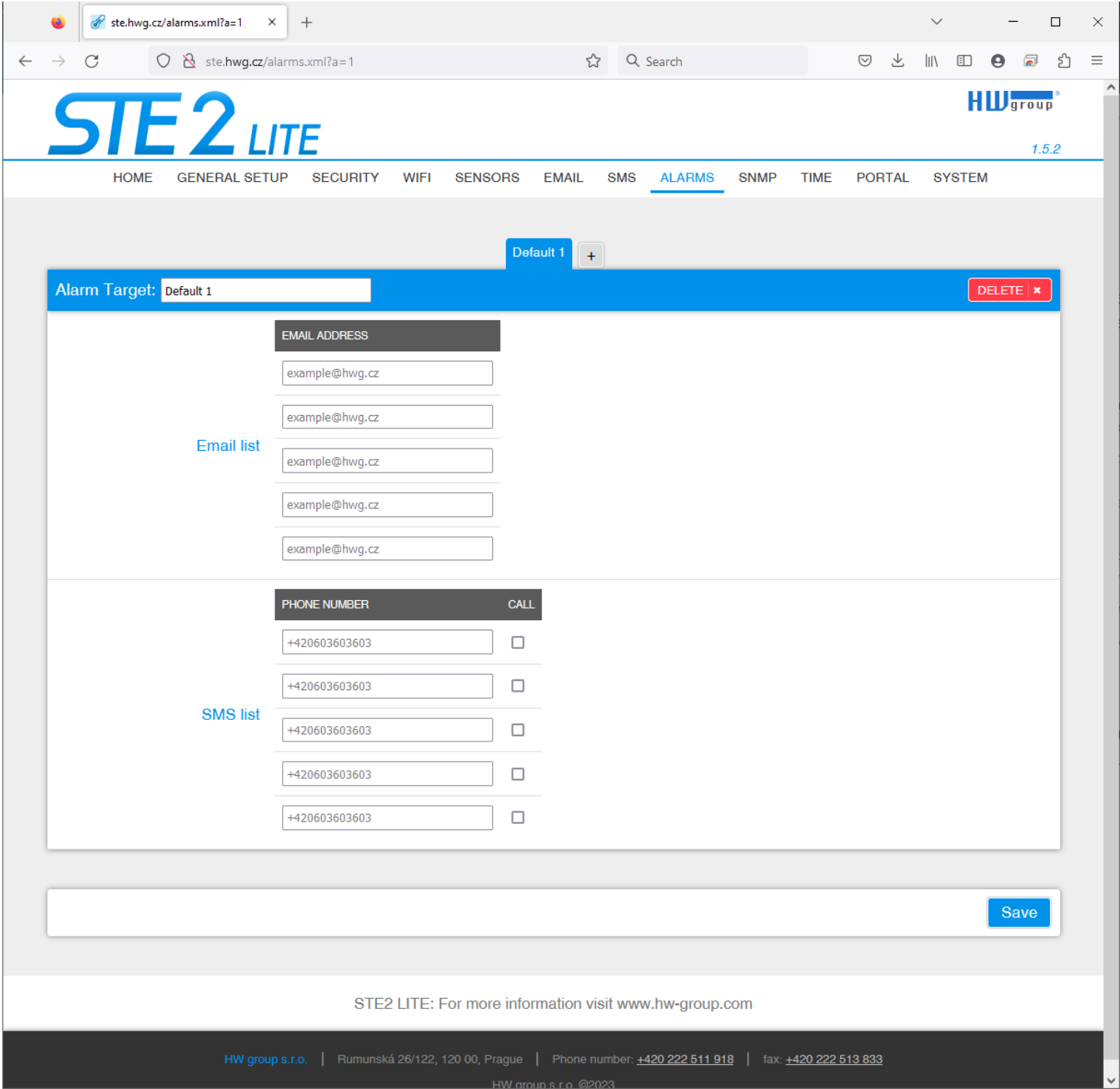

SNMP tab

The SNMP tab configure parameters for Open API - SNMP protocol

The screenshot shows the STE2 LITE web interface. The top navigation bar includes: HOME, GENERAL SETUP, SECURITY, WIFI, SENSORS, EMAIL, SMS, ALARMS, **SNMP**, TIME, PORTAL, SYSTEM. The version number 1.5.1 is displayed in the top right corner.

SNMP Settings

NAME	VALUE	DESCRIPTION
System Name	STE2 LITE 5905-D51C	0 to 32 characters
System Location		0 to 32 characters
System Contact	STE2 LITE	
SNMP port	161	Default port 161

[Show OID keys table](#)

SNMPv1 Access

COMMUNITY	READ	WRITE	ENABLE
public	<input checked="" type="checkbox"/>	<input type="checkbox"/>	<input checked="" type="checkbox"/>
private	<input checked="" type="checkbox"/>	<input checked="" type="checkbox"/>	<input checked="" type="checkbox"/>

[Save](#)

SNMP Settings section

- **System Name** - The name of the device within SNMP.
- **System Location** - The location of the device within SNMP.
- **System Contact** - Contact for the device administrator within SNMP.
- **SNMP Port** - The port number on which SNMP can communicate - 161 by default.

SNMPv1 Access section

- **Community** - The name of the SNMP community for accessing the device over SNMPv1. 2 communities can be defined. For each Community you can define whether it has permissions for:
 - **Read** - Enables or disables the read function.
 - **Write** - Enables or disables the write function.
 - **Enable** - Enables or disables a specific community.

Show OID keys table

This function lists the entire tree of variables with the full SNMP OID and explanations about the type variables. A MIB is also available for connecting devices to 3rd party monitoring systems.

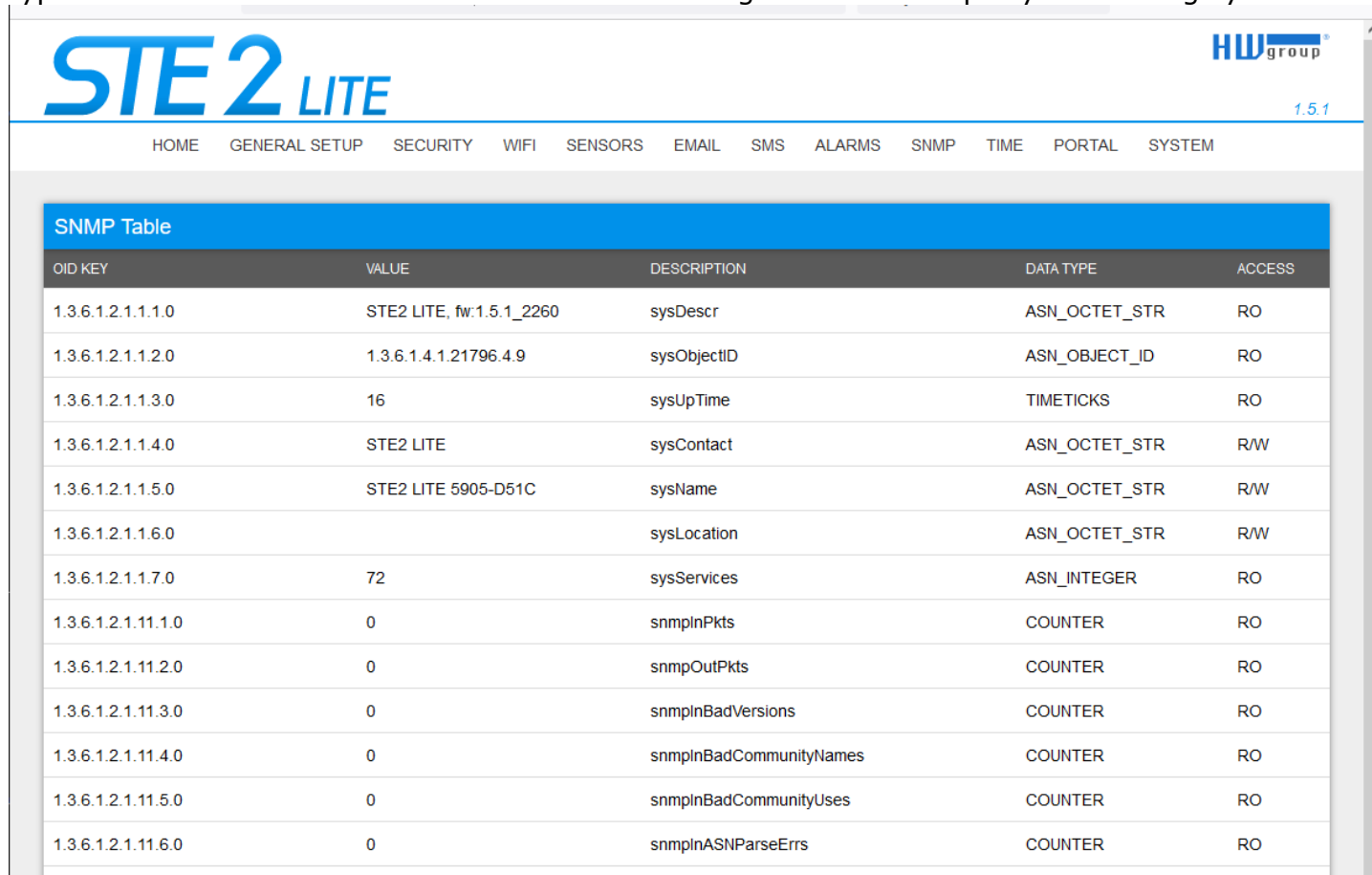

OID KEY	VALUE	DESCRIPTION	DATA TYPE	ACCESS
1.3.6.1.2.1.1.1.0	STE2 LITE, fw:1.5.1_2260	sysDescr	ASN_OCTET_STR	RO
1.3.6.1.2.1.1.2.0	1.3.6.1.4.1.21796.4.9	sysObjectID	ASN_OBJECT_ID	RO
1.3.6.1.2.1.1.3.0	16	sysUpTime	TIMETICKS	RO
1.3.6.1.2.1.1.4.0	STE2 LITE	sysContact	ASN_OCTET_STR	R/W
1.3.6.1.2.1.1.5.0	STE2 LITE 5905-D51C	sysName	ASN_OCTET_STR	R/W
1.3.6.1.2.1.1.6.0		sysLocation	ASN_OCTET_STR	R/W
1.3.6.1.2.1.1.7.0	72	sysServices	ASN_INTEGER	RO
1.3.6.1.2.1.11.1.0	0	snmplnPkts	COUNTER	RO
1.3.6.1.2.1.11.2.0	0	snmpOutPkts	COUNTER	RO
1.3.6.1.2.1.11.3.0	0	snmplnBadVersions	COUNTER	RO
1.3.6.1.2.1.11.4.0	0	snmplnBadCommunityNames	COUNTER	RO
1.3.6.1.2.1.11.5.0	0	snmplnBadCommunityUses	COUNTER	RO
1.3.6.1.2.1.11.6.0	0	snmplnASNParseErrs	COUNTER	RO

Download the MIB file in the System section (Download MIB file).

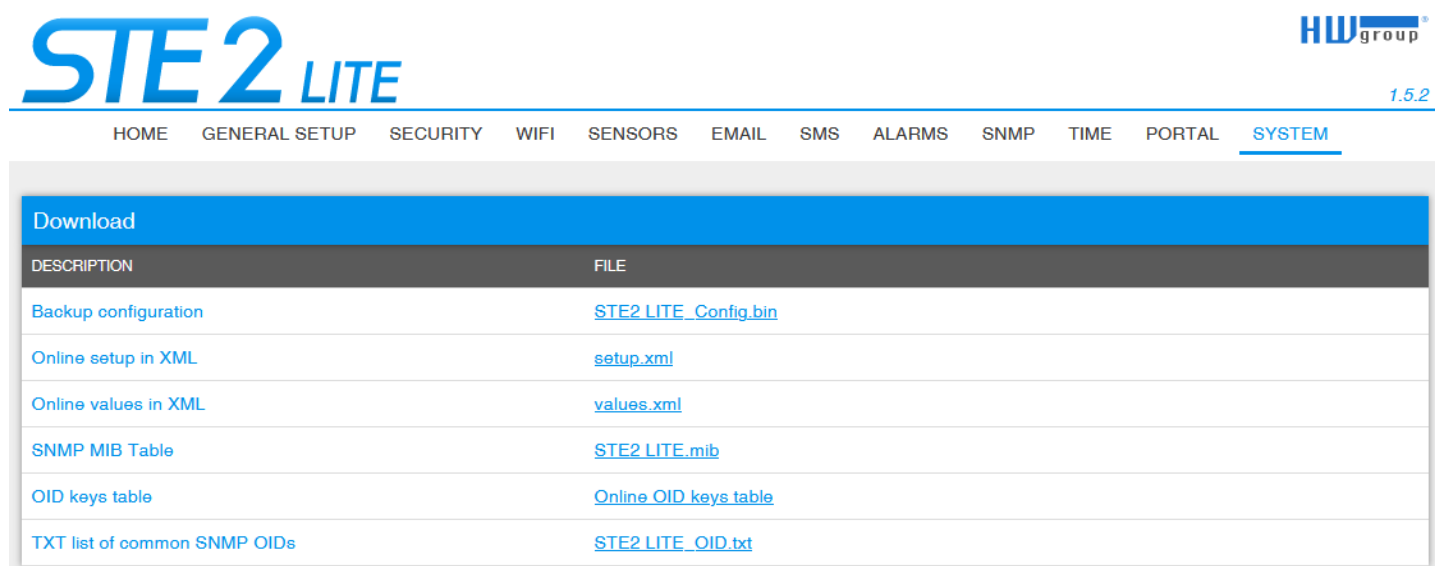

DESCRIPTION	FILE
Backup configuration	STE2 LITE_Config.bin
Online setup in XML	setup.xml
Online values in XML	values.xml
SNMP MIB Table	STE2 LITE.mib
OID keys table	Online OID keys table
TXT list of common SNMP OIDs	STE2 LITE_OID.txt

Time tab

The screenshot shows the STE2 LITE web interface with the 'TIME' tab selected. The interface includes a navigation menu with options: HOME, GENERAL SETUP, SECURITY, WIFI, SENSORS, EMAIL, SMS, ALARMS, SNMP, TIME, PORTAL, and SYSTEM. The 'TIME' tab is active, displaying three main sections: SNTP Settings, Time Settings, and SNTP Log.

SNTP Settings

NAME	VALUE	DESCRIPTION
SNTP Server	europa.pool.ntp.org	IP Address or DNS Name
Time Zone	1 : 0 min	Number -12 ... +13
Summertime	<input checked="" type="checkbox"/> Central European	last Sun March 2:00 - last Sun October 3:00
Interval	1h	Sync period: Off/1h/24h

Time Settings

NAME	VALUE	DESCRIPTION
Time	10:55:32	hh:mm:ss
Date	20.04.2023	dd.mm.yyyy

Buttons: Set browser's datetime, Set Time manually

SNTP Log

Debug log window.

Buttons: Synchronize

SNTP Settings section

- **SNTP Server** - IP address or domain address of the time synchronization server; europa.pool.ntp.org.
- **Time Zone** - Set the time zone of the device location. Used to set the correct system time. Necessary for correct recording of measured values.
- **Summertime** - Enable daylight saving time. Used to set the correct system time. Required for correct recording of measured values.
- **Interval** - Interval of time synchronization with the server.

Time Settings section

Allows you to fill in the current date and time manually when synchronization with the time server cannot be used.

SNTP Log section

The Sync button is used to perform an instant synchronization with the time server. It can also be used to test the settings.

Portal tab

Configure parameters how is the device connected to remote SensDesk Technology based portal. It's using HTTP connection, HWg-PUSH protocol. More about the protocol or support of portal solutions are available on the website <http://www.HW-group.com>.

Default preconfigured portal is www.HWg-cloud.com, but **you have to enable Portal** on the device web configuration and define portal account name and password.

There are several portals available except www.HWg-cloud.com or www.SensDesk.com (provided by HW group). Check the **Portal providers**.

The screenshot shows the web configuration interface for the STE2 LITE device, specifically the Portal tab. The browser address bar shows the URL 192.168.103.230/portal.xml. The page title is STE2 LITE and the HWgroup logo is visible in the top right corner. The navigation menu includes HOME, GENERAL SETUP, SECURITY, WIFI, SENSORS, EMAIL, SMS, ALARMS, SNMP, TIME, PORTAL (selected), and SYSTEM.

The Portal Message section shows "Portal disabled_".

The Portal settings section contains a table with the following data:

NAME	VALUE	DESCRIPTION
Portal	<input type="checkbox"/>	Portal Enable/Disable
Server Address	<input type="text" value="http://hwg-cloud.com/portal.php"/>	IP Address or DNS Name
IP Port	<input type="text" value="80"/>	Default 80
Team (provided by portal)	<input type="text"/>	Push device access parameters
Team Password (provided by portal)	<input type="text"/>	Please have a look at My Team on Sensdesk

The AutoPush settings section contains a table with the following data:

ID	NAME	TYPE	CURRENT VALUE	AUTOPUSH
22827	Sensor 22827	Temp.	28.4 °C	<input type="text" value="5.0"/>

A "Save" button is located at the bottom right of the AutoPush settings section.

The Portal Debug Log section contains a table with the following data:

NAME	VALUE	DESCRIPTION
Push Period:	900	[seconds]
Log Period:	300	[seconds]
Current Push Timer:	0	[seconds]
Current Log Timer:	0	[seconds]
Current Check Timer:	0	[seconds]
AutoPush Block Timer:	0	[seconds]
Retransmit number:	0	

Portal Message section

Feedback from the portal containing e.g. links to graphs, etc. Depends on the portal type.

Portal settings section

- **Portal** – Enables or disables this function.
- **Server address** – Complete URL of the remote server. Connection to HWg-cloud.com portal is prepared, but without account name.
- **IP Port** – Port to which the portal tunes in.
- **Team** – Name of the Portal Team to which the device should be assigned. You can find it on your portal on the “**My Team**” tab.
- **Team Password** – Password of the Team (HWg Push protocol) to which the device should be assigned.

The screenshot shows the HWg Cloud portal settings for a team named 'rehak'. The page is divided into several sections:

- Navigation:** Includes 'Adopt device', 'My account', 'My team' (highlighted with a red box), 'About', 'Help', 'License', 'Log out', and 'Settings'.
- Team rehak:** Shows options for 'View', 'Edit', 'Audit trail', 'values.xml', and 'Mobile app', along with a 'Buy Tariff' button.
- PORTAL SETTINGS:** A section containing the following information:
 - This is credential for your devices.
 - Portal URL:** http://hwg-cloud.com/portal.php
 - Portal port:** 80
 - Team:** rehak
 - Team password:** cBs6TZ
 - PUSH configurations: Default, NB Power Default, NB Battery Default, Frozen.
- LIMITS:** A table showing various limits for the team 'rehak':

Limit	Value	Used
Team:	Team rehak	
Date of expiration:		
Action - E-mail limit:	- Unlimited -	1 used
Action - Set output limit:	- Unlimited -	0 used
Action - SMS limit:	- Unlimited -	0 used
Action - SNMP trap limit:	- Unlimited -	0 used
Dashboard limit:	1	1 used
Device limit:	20	1 used
Device group limit:	- Unlimited -	0 used
Location limit:	- Unlimited -	2 used
Log limit (days):	10	
Multigraph limit:	0	0 used
Notice limit:	- Unlimited -	1 used
Report limit:	0	0 used
Target limit:	- Unlimited -	1 used
User limit:	4	1 used
User SNMP enabled:	Enabled	
values.xml enabled:	Enabled	
- Default dashboard:** Team_dashboard rehak
- Default permission group:** (indicated by a gear icon)
- Default SMS gateway address:**

Portal Debug Log section

For debugging only. Event counters + Debug window for sending data to the portal.

- **Push Period** – Period of sending data to the remote portal. The period is determined by the portal and cannot be changed by the user.
- **Log Period** – Period of storing data for the portal in the cache. The period is determined by the portal and cannot be changed by the user.
- **Current Push Timer** – Timer indicating the time remaining until sending data to the portal.
- **Current Log Timer** – Timer indicating the time remaining until saving the data for the portal in the cache.
- **AutoPush Block Timer** – Time of incidents for AutoPush. If the permitted number of incidents for one Push period is exceeded, the AutoPush function will be blocked.
- **Retransmit number** – Counts the number of invalid Push attempts.
- **Manual Push** – Button for instant sending of data to the portal.

The AutoPush functionality

The device sends sensor data to the online portal at regular intervals defined by the portal. For the HWg-cloud.com portal, the default interval is every 15 minutes and cannot be changed by the user.

Alarming on the portal is based on 2 functions:

- **Notice Range** – alarming is fully managed in the portal. Reaction time up to 15 min.
- **SD SafeRange** - alarming is managed in the portal, but MIN & MAX values of the Safe Range are synchronized with the device. This helps respond to alarms faster when sensor values pass the alarm limits.

AutoPush settings for each Sensor

AutoPush sends data to the portal faster when sensor values change by a certain amount since the last upload. When this happens, the STE2 device automatically connects to the portal and sends updated values for all sensors.

System tab



1.5.1

HOME GENERAL SETUP SECURITY WIFI SENSORS EMAIL SMS ALARMS SNMP TIME PORTAL SYSTEM

Portal Message

Portal disabled_

Portal settings

NAME	VALUE	DESCRIPTION
Portal	<input type="checkbox"/>	Portal Enable/Disable
Server Address	<input type="text" value="http://hwg-cloud.com/portal.php"/>	IP Address or DNS Name
IP Port	<input type="text" value="80"/>	Default 80
Team (provided by portal)	<input type="text"/>	Push device access parameters Please have a look at My Team on Sensdesk
Team Password (provided by portal)	<input type="text"/>	

AutoPush settings

ID	NAME	TYPE	CURRENT VALUE	AUTOPUSH
22827	Sensor 22827	Temp.	28.4 °C	<input type="text" value="5.0"/>

Portal Debug Log

NAME	VALUE	DESCRIPTION
Push Period:	900	[seconds]
Log Period:	300	[seconds]
Current Push Timer:	0	[seconds]
Current Log Timer:	0	[seconds]
Current Check Timer:	0	[seconds]
AutoPush Block Timer:	0	[seconds]

Download section

- **Backup configuration** – Configuration backup in BIN format. Click on the link to save the current device configuration after its final settings for potential restore purposes.
- **Online setup in XML** – Configuration backup in XML format. Click on the link to save the current device configuration after its final settings for potential restore purposes.
- **Online values in XML** – Current values in XML format. Click on the link to save the current device configuration after its final settings for potential restore purposes.
- **SNMP MIB Table** – SNMP MIB file. MIB file address containing the definition of SNMP variables.
- **OID keys table** – The function will draw up the entire tree of variables with an indication of the entire SNMP OID and explanations of the variable type.
- **TXT list of common SNMP OIDs** – Overview of the most important OID from the MIB table.

System section

- **Product Name** – Device name (type).
- **Serial Number** – Device serial number.
- **Eth MAC Address** – MAC address of the device for cable connection.
- **WiFi STA MAC Address** – MAC address of the device for WiFi connection.
- **Version** – Firmware version. Serves for diagnostic purposes when solving problems.
- **Build** – Serves for diagnostic purposes when solving problems.
- **Compile time** – Firmware compile time. Serves for diagnostic purposes when solving problems.
- **UpTime** – Runtime of the device since the last switching on or restarting. Serves for diagnostic purposes when solving problems.
- **Demo mode** – Active demo mode prevents any changes in your device configuration. In this mode, users can browse and view all the web interface pages, but they are not allowed to change any values. A device with this setting can be placed on the public internet with no risk of changes in its configuration. Demo mode can be turned off in the same way after entering the password.
- **Read available version** – Lists the latest version of firmware on the HW group update server.
- **Start Network Upgrade** – Launches a firmware upgrade from the HW group update server.
- **Upload Firmware or Configuration** – Install newer firmware or configuration files to the device.

Restore configuration may not work if there is too large a difference in firmware versions.

Factory Default section

Restores factory settings. By default, DHCP setup is enabled. If the device does not receive an address within 60 seconds of switching it on, it defaults to 192.168.10.20 as the default IP. Neither the username nor the password is defined by default.

System Restart section

Restarts the device.

Technical parameters

Ethernet	
Interface	RJ45 (10/100BASE-T)
Supported protocols	IP: ARP, TCP/IP (HTTP, HTTPS, SNMP, SMTP, HWg-Push, netGSM, TLS), UDP/IP (SNMP, Syslog)
SNMP	Version 1
WiFi	
Supported standards	802.11 b/g/n
Frequency	2.4GHz
Output	+19.5 dBm output power in 802.11b mode +16 dBm for 802.11n
Security	WEP / WPA / WPA2 PSK / WPA2 TSK / WPS
Antenna	Internal
External sensors	
Port/connector	Port1- RJ11 (1W-UNI)
Values limit	Up to 4 sensor values (°C, %RH, WLD, Voltage ...)
Sensor type	Only sensors from HW group s.r.o.
Sensors/distance	Max 60 meters total length
Power supply	
Power voltage	5V / 250 mA
Connector	Connector Jack Ø3.5 x 1.35 / 10 [mm]
LED	
LINK	Green – Ethernet connection state
Activity	Activity Yellow – Ethernet activity
WiFi	Blue – connection state in operation (shining), search indicator (flashing slowly) and connection (flashing quickly)
Button	
Reset	Restore default settings: hold or 5 seconds after connecting power supply.
Other parameters	
Operating temperature	-10 to 60 °C (device operating temperatures) Sensors temperature range can be very different
Dimensions/weight	63 x 67 x 29 (WxHxD) / 64g
Elmag. radiation	CE / FCC Part 15, Class B
Elmag. compatibility	EN 61326-1:2013, EN 61010-1:2010, EN 55011:2009, EN 62311:2008

Physical dimensions

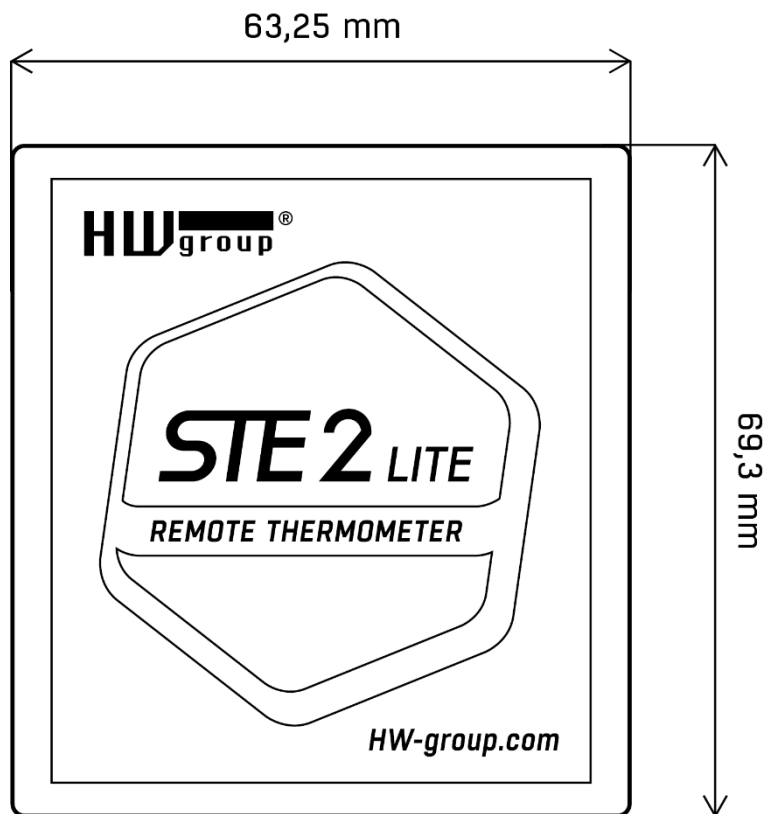
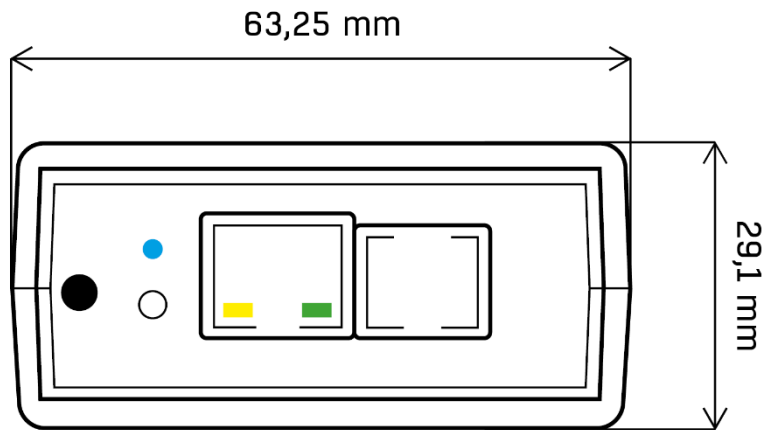

WiFi Radio

Description	Min	Typical	Max	Unit
Input frequency	2412	-	2484	MHz
Tx power				
The output power of PA for 72.2 Mbps	13	14	15	dBm
The output power of PA for 11b mode	19,5	20	20,5	dBm
Sensitivity				
DSSS, 1 Mbps	-	-98	-	dBm
CCK, 11 Mbps	-	-91	-	dBm
OFDM, 6 Mbps	-	-93	-	dBm
OFDM, 54 Mbps	-	-75	-	dBm
HT20, MCS0	-	-93	-	dBm
HT20, MCS7	-	-73	-	dBm
HT40, MCS0	-	-90	-	dBm
HT40, MCS7	-	-70	-	dBm
MCS32	-	-89	-	dBm
Adjacent Channel Rejection				
OFDM, 6Mbps		37		dB
OFDM, 54Mbps		21		dB
HT20, MCS0		37		dB
HT20, MCS7		20		dB

WiFi signal strength

What is signals strength

WiFi is a radio signal and it has limitations in reach given firstly by the transmission output and by the quality and shape of the antennas. Signal strength is indicated in decibels per milliwatt of output (dBm), often (incorrectly) simplified to "dB". Signal strength has a negative value and it applies that the lower the value (a higher number after the negative sign), the worse.

The decibel unit is non-dimensional and expresses the logarithm of a ratio of two values. In our case, it is the ratio of received output to an etalon of 1 mW:

$$dBm = 10 * \log_{10} \frac{P_1}{1 \text{ mW}}$$

This means that if you have a signal of -54 dBm, it is higher (better) than a value of -82 dBm.

Device orientation with relation to the WiFi transmitter

In terms of sensitivity, flat antennas perform equally well or even better than multi-directional antennas (provided that the transition connector is excluded). However, flat antennas are mainly disadvantaged by their sensitivity to the positioning of the device relative to the connection point.

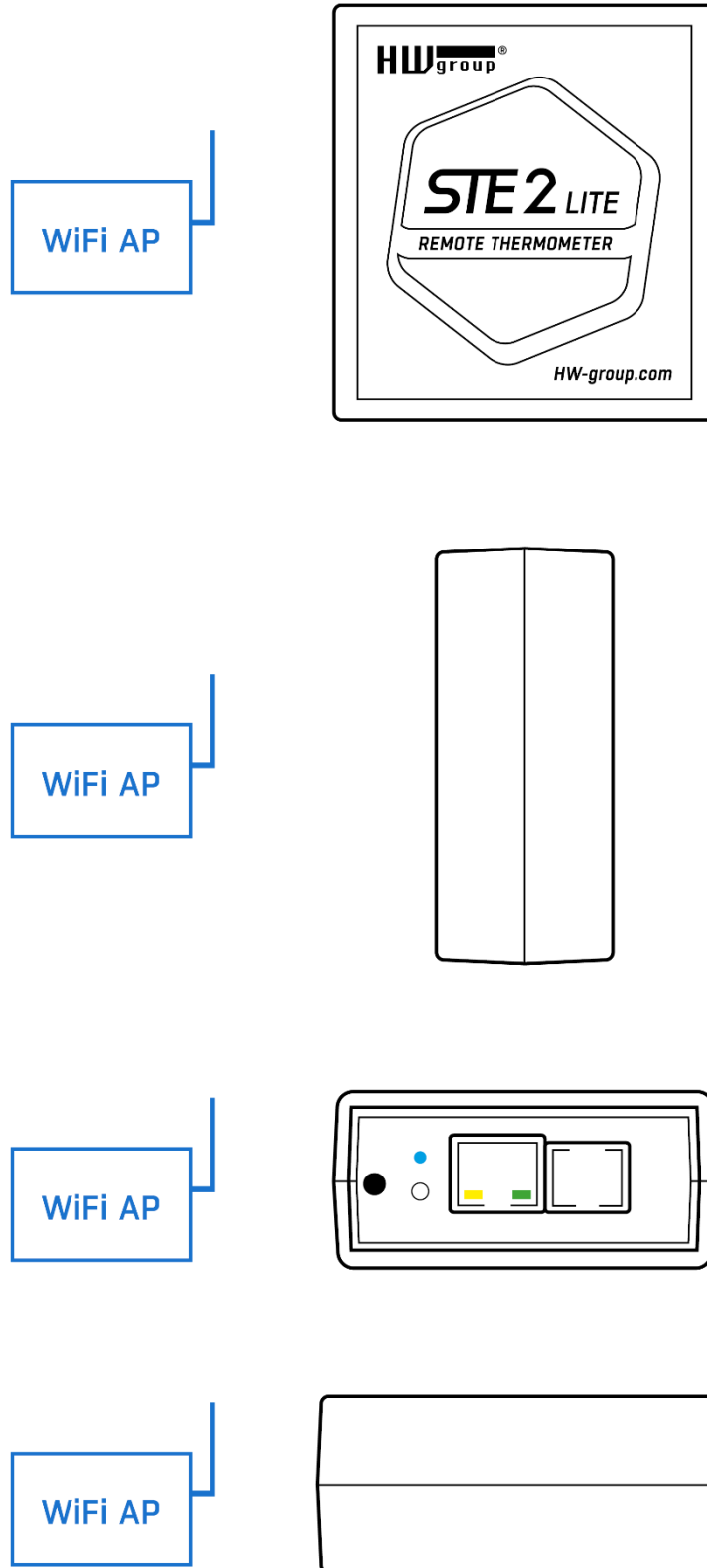

Supported interfaces

Sensors RJ11 (1W-UNI bus)

Digital sensor bus, each sensor has a unique ID.

- STE2 LITE has 1 RJ11 port
- Each port support max distance 60m.
- Power: 5 V / 20 mA from RJ11 port.
- You can connect one RJ11 sensor to each port
- You can connect several physical RJ11 sensors to one port. Sensors can be daisy-chain with respect to total max distance.
- To help sensors daisy-chain, some sensors have 2 RJ11 ports.
- Avoid star topology (RJ11 splitters).
- Only sensors from HW group are supported. Do not connect any other sensors, it can damage device.

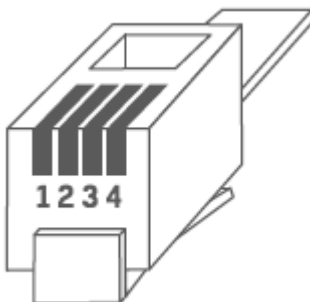

RJ11 (1W-UNI)		
1.	-	Not used
2.	Data	2 Data Transmit Data
3.	GND	3 GND Ground
4.	+5V	4 +5V Power

Note:

If a cable line is more than 60 meters from one connector on the device, we can't guarantee it will work perfectly. It depends on the type of cable, how the line is set up, and the environment where it's installed.

In case of troubles, check your cable and RJ11 connectors quality.

Sensor values limit

Several sensor values can be connected to the device. Sensors can be daisy-chained from RJ11 port. One physical sensor can measure several sensor values ($^{\circ}\text{C} + \%RH = 2$ sensor values).

- STE2 LITE maximum limit is 4 sensor values in total.
- There can be limit based on powering external sensors. Contact our supports.

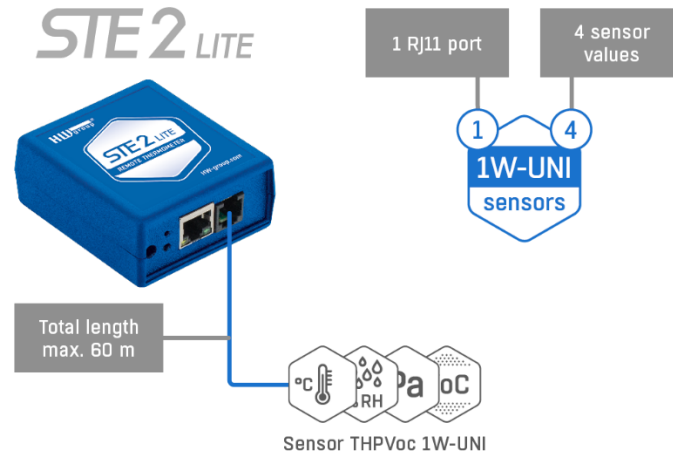

Available 1W-UNI sensors:

- Temperature sensors (Indoor / Outdoor / Cryo)
- Calibrated temperature sensors
- Relative Humidity sensors (Indoor / Outdoor)
- CO2 & VOC sensors
- Light sensor
- AC / DC Current sensors
- AC Voltage sensor (0-230V)
- 4-20 mA sensors (converter) for industrial probes
- Water flood detector (spot detection)
- WLD (Water Leak Detection) with an external sensing cable

Connecting STE2 to the SensDesk portal

1. Connect the device to the computer network and set the network parameters (see the First Steps chapter).

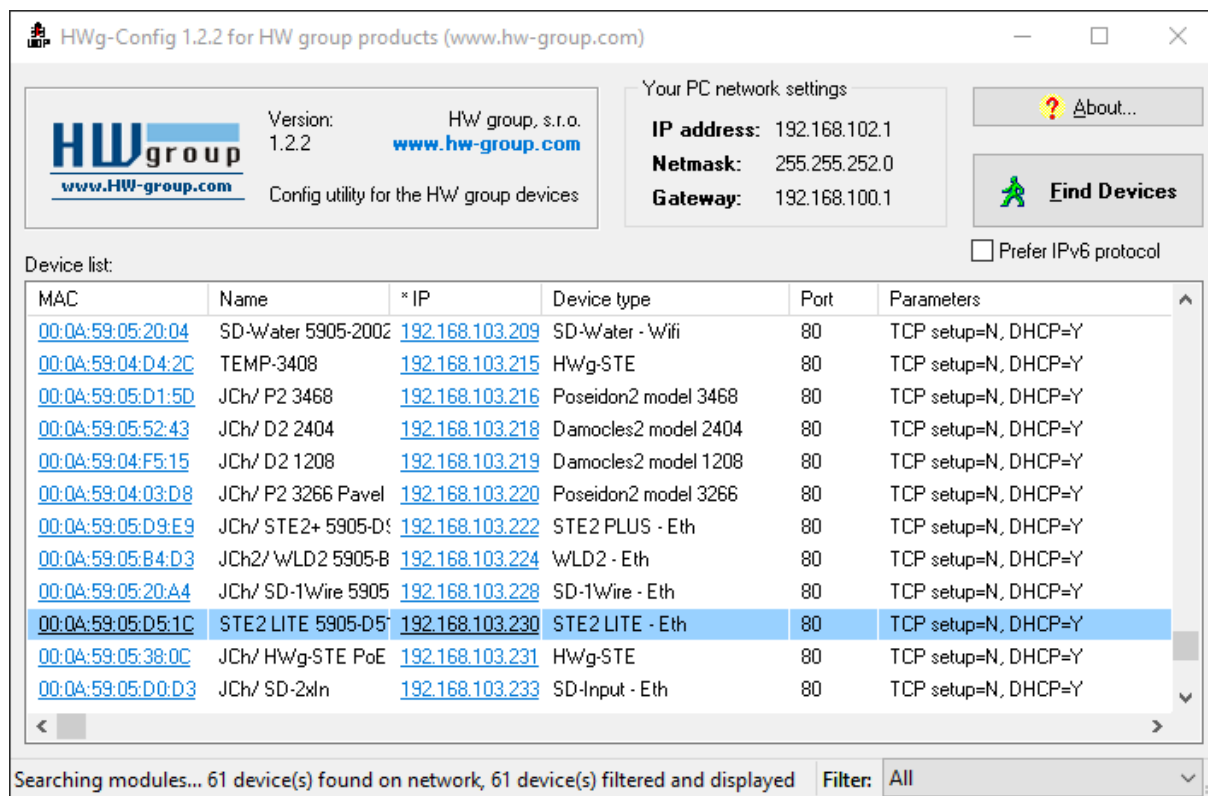

2. Check the device website:

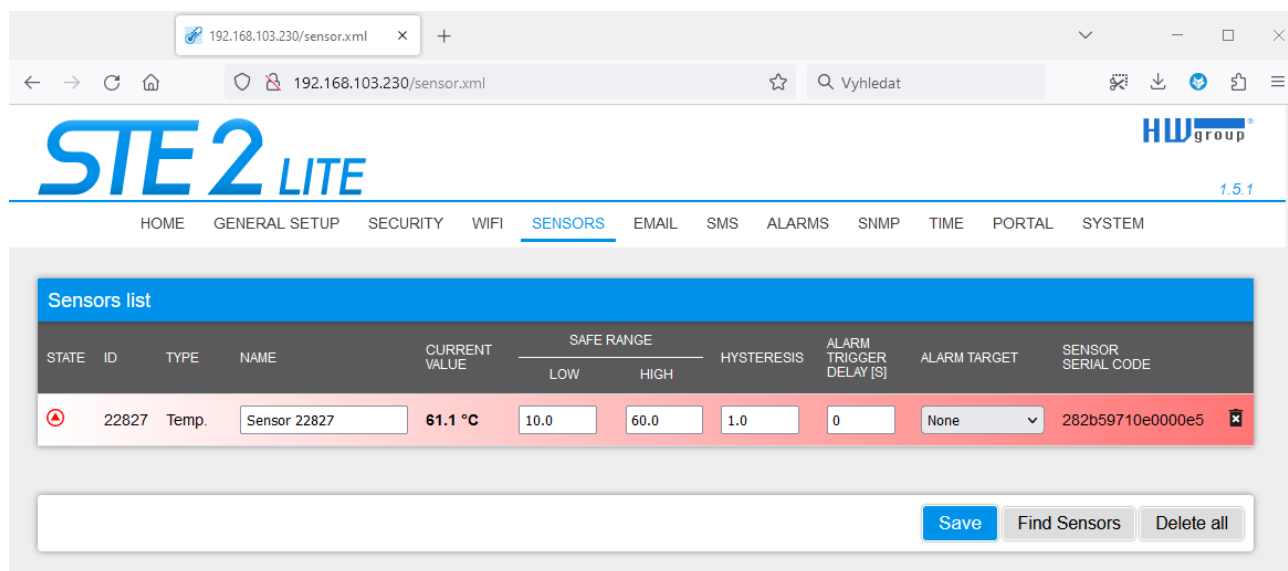

3. Tick the Enable Portal option and save the changes using the Save button in the bottom right corner of the window.

Then click the Manual Push button in order to activate the portal function. Instead of "Portal disabled", a link SensDesk.com: register your IP sensor should appear in the Portal Message field. Click this link in order to get to the SensDesk.com portal.

STE2 LITE

1.5.1

HOME
GENERAL SETUP
SECURITY
WIFI
SENSORS
EMAIL
SMS
ALARMS
SNMP
TIME
PORTAL
SYSTEM

Portal Message

HWg-cloud: Register your IP sensor and fill Team and Team Password correctly (2023-04-20 09:10:45 UTC)

Portal settings

NAME	VALUE	DESCRIPTION
Portal	<input checked="" type="checkbox"/>	<i>Portal Enable/Disable</i>
Server Address	<input type="text" value="http://hwg-cloud.com/portal.php"/>	<i>IP Address or DNS Name</i>
IP Port	<input type="text" value="80"/>	<i>Default 80</i>
Team (provided by portal)	<input type="text"/>	<i>Push device access parameters Please have a look at My Team on Sensdesk</i>
Team Password (provided by portal)	<input type="text"/>	

AutoPush settings

ID	NAME	TYPE	CURRENT VALUE	AUTOPUSH
22827	Sensor 22827	Temp.	27.8 °C	<input type="text" value="5.0"/>

Portal Debug Log

NAME	VALUE	DESCRIPTION
Push Period:	900	<i>[seconds]</i>
Log Period:	300	<i>[seconds]</i>
Current Push Timer:	658	<i>[seconds]</i>
Current Log Timer:	216	<i>[seconds]</i>
Current Check Timer:	0	<i>[seconds]</i>
AutoPush Block Timer:	0	<i>[seconds]</i>
Retransmit number:	0	

```
20.04.2023, 11:10:45
Push data start
Server Address: http://hwg-cloud.com/portal.php
Push SUCCESS
```

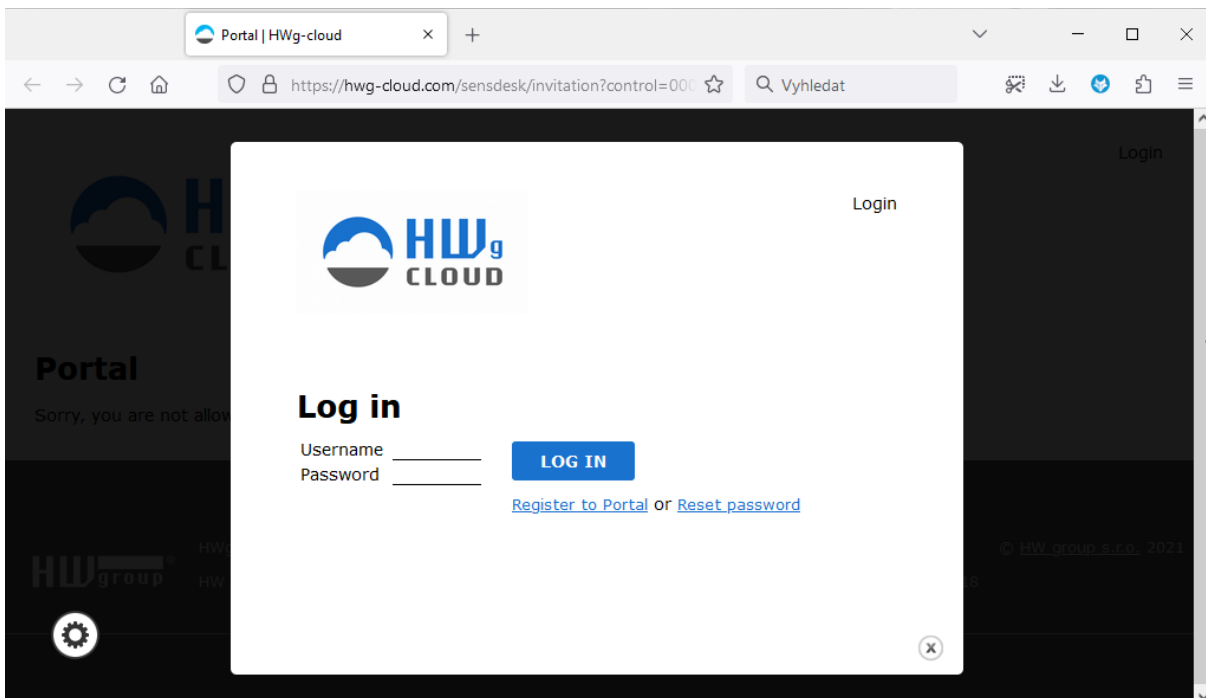

4. In case you already have a user account, please enter your login details and the device will be automatically assigned to your account. If you do not have a SensDesk account yet, click the Register and a registration form will be shown.

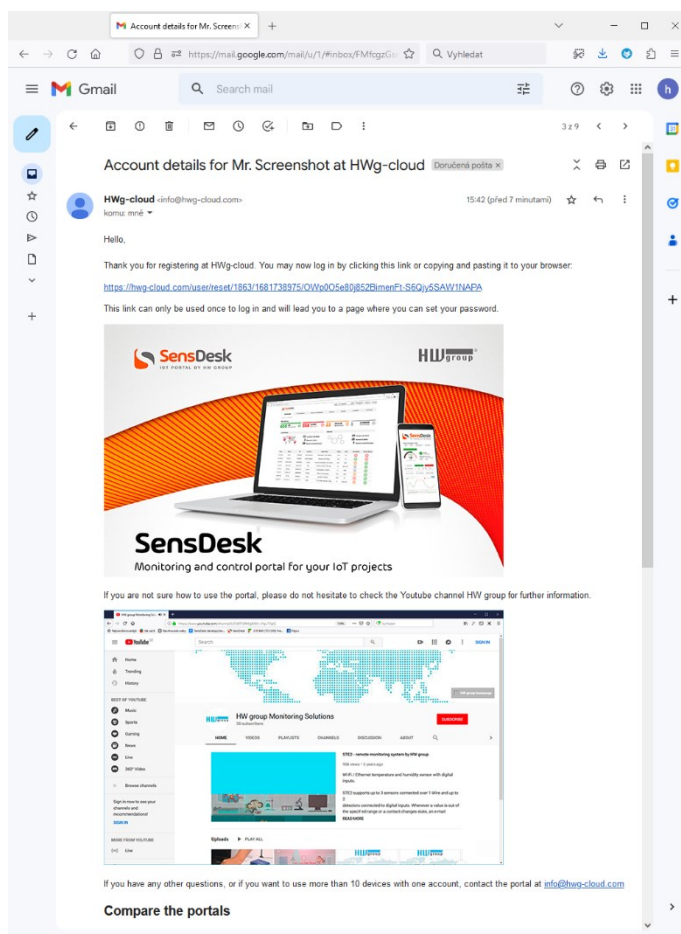
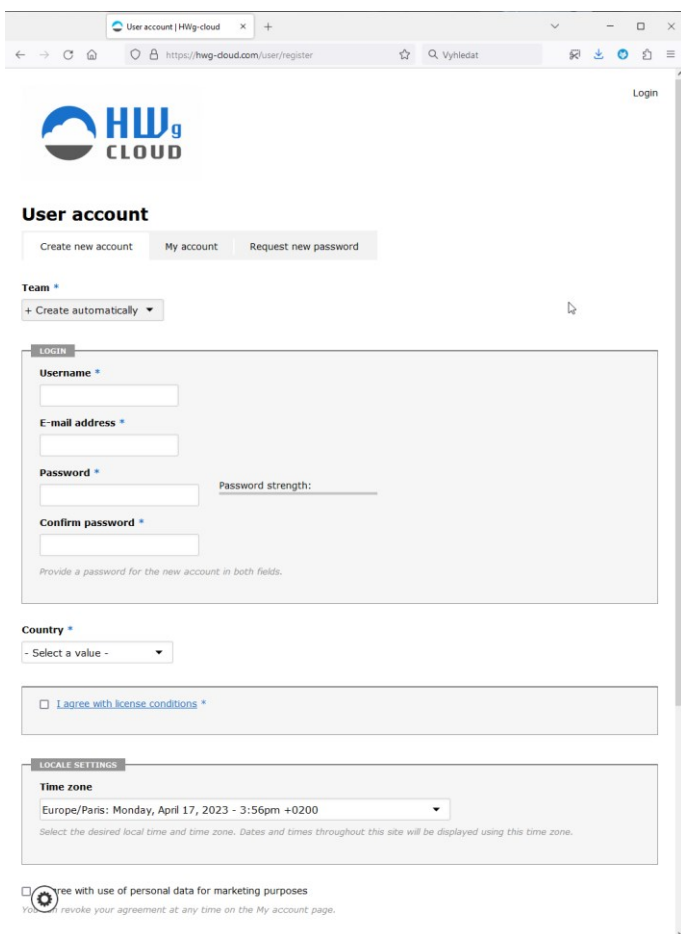

5. Enter the login details for your new account and the correct email address. This email address has to be unique for the server (cannot be already registered by another user).

HWg CLOUD

Mr. Screenshot
Adopt device

BUY TARIFF

Dashboards | Devices | Sensors | Locations | Device groups | Multigraphs | Settings

Home

STE2 LITE 5905-D51C

View | Edit | Edit sensors | Actions | EventLog | Delete | Debug

Last log: 20.04.2023 11:13

Device groups: Not assigned
Location: Not assigned
IP Address: 192.168.103.230 port: 80
[Migrate device to another SensDesk technology based portal](#)



Sensor 22827

SAFE RANGE: 10 - 60
27.8 °C
Last update 11 sec ago

6. By activating the account, you will be redirected to the Devices > View page. At this moment, the data-sending period is set to 10 seconds to show the functionality of the sensors. This page is active only for approximately 15 minutes after the activation, then the logging period changes to 15 minutes.

Team Mr. Screenshot | HWg-cloud X

https://hwg-cloud.com/sensdesk/team/my

HWg CLOUD

Mr. Screenshot
Adopt device

BUY TARIFF

Dashboards | Devices | Sensors | Locations | Device groups | Multigraphs | Settings

Home » Settings

Team Mr. Screenshot

View | Edit | Audit trail **Buy Tariff**

SMS

Gateway: - None -

PORTAL SETTINGS

This is credential for your devices.
Portal URL: http://hwg-cloud.com/portal.php
Portal port: 80
Team: Mr. Screenshot
Team password: 5Jt5J

LIMITS

Team: Team Mr. Screenshot
Date of expiration:
Action - E-mail limit: - Unlimited - 0 used
Action - Set output limit: 0 0 used
Action - SMS limit: 0 0 used

7. If you check the Teams link, you will find your Team Password.

This password, together with your login name, identifies the device in communication with your account and in the communication of mobile applications with SensDesk. The password cannot be changed and for security reasons, it is different to the login password.

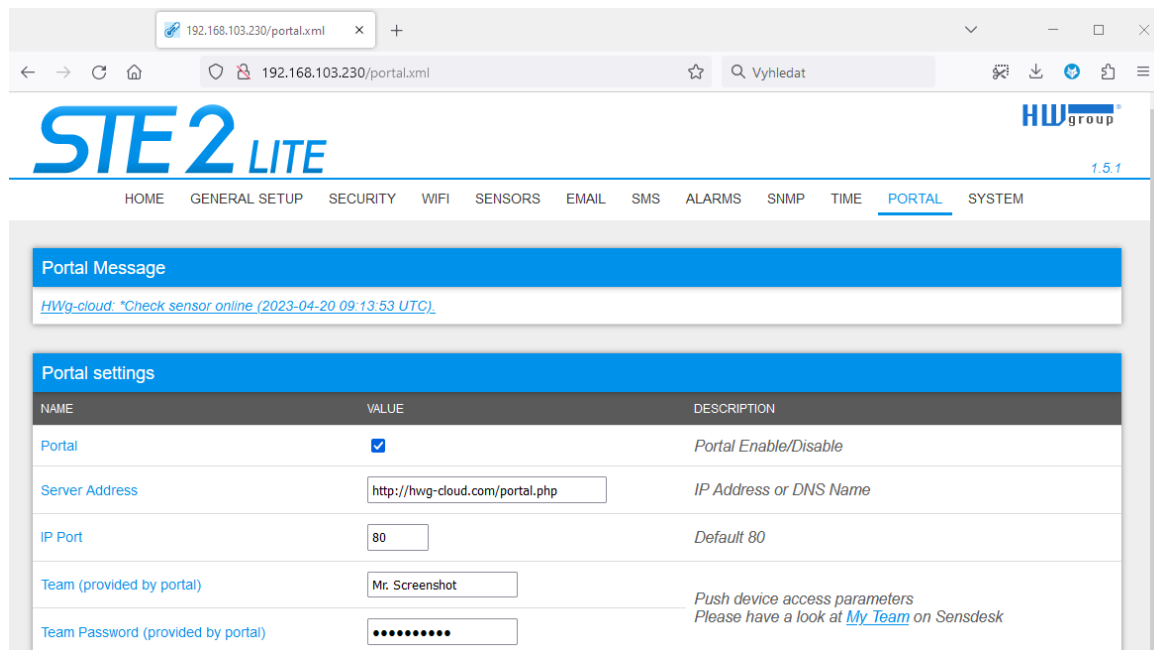

Portal Message

*HWg-cloud: *Check sensor online. (2023-04-20 09:13:53 UTC)*

Portal settings

NAME	VALUE	DESCRIPTION
Portal	<input checked="" type="checkbox"/>	Portal Enable/Disable
Server Address	<input type="text" value="http://hwg-cloud.com/portal.php"/>	IP Address or DNS Name
IP Port	<input type="text" value="80"/>	Default 80
Team (provided by portal)	<input type="text" value="Mr. Screenshot"/>	Push device access parameters Please have a look at My Team on Sensdesk
Team Password (provided by portal)	<input type="password" value="....."/>	

8. Team Password can be used in devices to skip the logging procedure during assigning the device to your portal account, or in mobile applications:

Portal function periodically sends the data to a remote server and the sending period is set by this server.

AutoPush is a function allowing unusual measured data sending, beside the periodical logging, in case that the value change is higher than the AutoPush delta parameter.

HWg Monitor - mobile app

HWg Monitor lets users check values from one or more HWg devices regularly. It reads data from either the LAN or the Portal (Cloud) and mainly helps show sensor values.

The app also lets you sort sensors by device or prioritize which ones show up first. Sensors in alarm or disconnected devices are marked with different colors.

Additionally, HWg Monitor can control Digital Outputs (DO) on Poseidon2 and Damocles2 devices connected directly to the LAN, as well as devices connected to the Portal.

- Mobile App for iOS and Android
- Can be used on Mobile phones, Tablets, Android compatible devices (TV).
- Indicate values from Sensors, DI, DO
- Data input
 - LAN devices (All HWg products)
 - Cloud Portal
 - SensDesk.com (HWg-cloud.com is not supported)
 - Portal Providers



HWg Monitor: Define sensor values zoom as you need

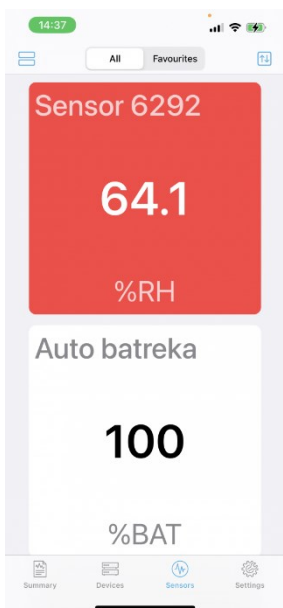

Specifics of selected SensDesk Technology portals:

The HWg Monitor application can work with all SensDesk Technology portals, but not all may have active support for this application. Support depends on the activation of XML API on the portal, which may be enabled or disabled by its operator. The HWg-Cloud.com portal has this support turned off and is only available on the paid version of SensDesk.com. Portals from other operators may have different settings, so users should ask their portal operator for support for this application.

Basic features of the HWg Monitor application:

- An unlimited number of monitored devices and sensors.
- Two types of data sources (Data source).
 - Direct communication with STE2, Poseidon2, Damocles2, HWg-PWR, WLD2 units.
 - Portals (Cloud) from the SensDesk Technology family with enabled integration (API) through XML (SensDesk.com, HWportal.cz, SensDesk.mcs-nl.com, and others).
- Option to select preferred sensors (favorites).
- Sorting options by name or status.
- Row or tile display.
- Integrated HWg config for searching devices on a local network.
- Clear the widget for a quick preview.
- Output control on directly connected Poseidon2 and Damocles2 units.
- Clear application for iOS and Android.
- Optional number of tiles on the screen for setting up large screens.

Find more: <https://www.hw-group.com/cs/software/hwg-monitor>

Firmware upgrade in STE2 LITE units

1) Open the device web interface in the System tab.

The screenshot shows a web browser window displaying the STE2 LITE web interface. The browser address bar shows the URL `192.168.103.230/system.xml`. The page header includes the STE2 LITE logo and the HW group logo. The navigation menu includes: HOME, GENERAL SETUP, SECURITY, WIFI, SENSORS, EMAIL, SMS, ALARMS, SNMP, TIME, PORTAL, and SYSTEM (highlighted). The main content area is divided into two sections:

Download

DESCRIPTION	FILE
Backup configuration	STE2 LITE_Config.bin
Online setup in XML	setup.xml
Online values in XML	values.xml
SNMP MIB Table	STE2 LITE.mib
OID keys table	Online OID keys table
TXT list of common SNMP OIDs	STE2 LITE_OID.txt

System

NAME	VALUE
Product Name:	STE2 LITE
Serial Number:	6008200005
Eth MAC Address:	00:0A:59:05:D5:1C
Wifi STA MAC Address:	00:0A:59:05:D5:1D

2) The System section contains items to identify and download the current FW version.

The screenshot shows the System section of the web interface. It contains a table with the following data:

NAME	VALUE
Product Name:	STE2 LITE
Serial Number:	6008200005
Eth MAC Address:	00:0A:59:05:D5:1C
Wifi STA MAC Address:	00:0A:59:05:D5:1D
Version:	1.5.1
Build:	2260
Compile time:	Feb 20 2023, 13:37:52
Up Time:	1355 [s]
Demo Mode:	Demo Mode
Network Upgrade	Read available version:--- Start Network Upgrade:---

Below the table, there is a section for uploading firmware or configuration:

Upload Firmware or Configuration: Soubor nevybrán.

3) Read available version – Serves to identify and display the current firmware version on the update server. Click on the Read available version link.

System	
NAME	VALUE
Product Name:	STE2 LITE
Serial Number:	6008200005
Eth MAC Address:	00:0A:59:05:D5:1C
Wifi STA MAC Address:	00:0A:59:05:D5:1D
Version:	1.5.1
Build:	2260
Compile time:	Feb 20 2023, 13:37:52
Up Time:	1355 [s]
Demo Mode:	Demo Mode
Network Upgrade	Read available version :1.5.2
	Start Network Upgrade :---
Upload Firmware or Configuration:	<input type="button" value="Procházet..."/> Soubor nevybrán. <input type="button" value="Upload"/> <input type="text"/>

4) Start Network Upgrade – Serves to upgrade firmware to the device. The download progress is displayed while upgrading. Click on the Start Network Upgrade link.

System	
NAME	VALUE
Product Name:	STE2 LITE
Serial Number:	6008200005
Eth MAC Address:	00:0A:59:05:D5:1C
Wifi STA MAC Address:	00:0A:59:05:D5:1D
Version:	1.5.1
Build:	2260
Compile time:	Feb 20 2023, 13:37:52
Up Time:	1355 [s]
Demo Mode:	Demo Mode
Network Upgrade	Read available version :1.5.2
	Start Network Upgrade : Download status: 131072 / 806096
Upload Firmware or Configuration:	<input type="button" value="Procházet..."/> Soubor nevybrán. <input type="button" value="Upload"/> <input type="text"/>

5) After the upgrade, the user is requested to restart the device manually.

System	
NAME	VALUE
Product Name:	STE2 LITE
Serial Number:	6008200005
Eth MAC Address:	00:0A:59:05:D5:1C
Wifi STA MAC Address:	00:0A:59:05:D5:1D
Version:	1.5.1
Build:	2260
Compile time:	Feb 20 2023, 13:37:52
Up Time:	1355 [s]
Demo Mode:	Demo Mode
	Read available version :1.5.2
Network Upgrade	Start Network Upgrade : Download done. Please restart.
Upload Firmware or Configuration:	<input type="button" value="Procházet..."/> Soubor nevybrán. <input type="button" value="Upload"/> <input type="text"/>

To do this, press the Restart button. **The device will not restart automatically and this must be done manually.**

Check the firmware version after restart.

System	
NAME	VALUE
Product Name:	STE2 LITE
Serial Number:	6008200005
Eth MAC Address:	00:0A:59:05:D5:1C
Wifi STA MAC Address:	00:0A:59:05:D5:1D
Version:	1.5.2
Build:	2260
Compile time:	Feb 20 2023, 13:37:52
Up Time:	1355 [s]
Demo Mode:	Demo Mode
	Read available version :1.5.2
Network Upgrade	Start Network Upgrade :---
Upload Firmware or Configuration:	<input type="button" value="Procházet..."/> Soubor nevybrán. <input type="button" value="Upload"/> <input type="text"/>



HW group, s. r. o.

Rumunská 26/122
Praha 2, 120 00
Česká republika

Tel.: +420 222 511 918
Fax: +420 222 513 833

www.HW-group.com

manual version: 1.0.1