

# OMNI-293

ANTENNAS | OMNI-293 SERIES

## OMNI-DIRECTIONAL, WIDEBAND 5G/LTE ANTENNA

617 – 3800 MHz, 9 dBi

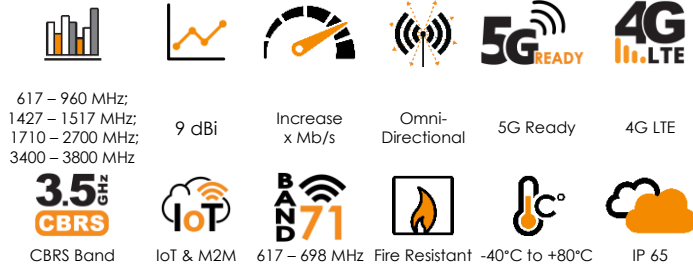

- High performance, ultra-wideband omni-directional antenna
- Consistent high gain over wide frequency band
- Excellent broadband quality antenna
- Ideal for Machine to Machine (M2M) and IoT applications
- Dust and water-resistant enclosure with IP65 rating



### Product Overview

The OMNI-293 is an ultra-wideband, high performance, omni-directional antenna that covers the contemporary 4G/LTE and future 5G operating frequencies with excellent balanced gain across all frequencies. The ultra-wideband performance from the antenna allows it to operate from 617 to 3800 MHz, with a peak gain of 9 dBi. The antenna is future proof as it covers the up and coming 617 to 698 MHz band, as well as 3400 to 3800 MHz which will be utilized for future 5G applications. This makes the antenna usable in all parts of the world and guarantees signal reception almost everywhere. The antenna design allows for superior pattern control over the entire frequency range, making the OMNI-293 a true high performance omni-directional antenna, suitable for urban and rural applications. The exceptional wideband performance is an important factor for LTE and future 5G technologies, where these technologies rely on features such as Carrier Aggregation (CA) to provide the best possible reception and throughput over multiple frequency bands simultaneously. The antenna comes with an N-Type female connector at its base, which can be connected to a cable of the desired type and length.

### Features

- High gain omni-directional antenna
- Includes 617 to 698 MHz band and 3.5 GHz 5G bands
- Wideband operation, makes the antenna future proof
- Antenna is purpose-built for urban and rural applications
- Robust and weather resistant design with IP65 rating

### Application Areas

- Improve data transmission connection reliability & stability
- Machine to Machine (M2M) & IoT applications
- High-end industrial grade router applications
- Areas with poor data signal reception
- Enhanced 4G/LTE and 5G reception



### Frequency Bands

The OMNI-293 is an omni-directional antenna that works from 617 – 960 MHz | 1427 – 1517 | 1710 – 2700 MHz | 3400 – 3800 MHz

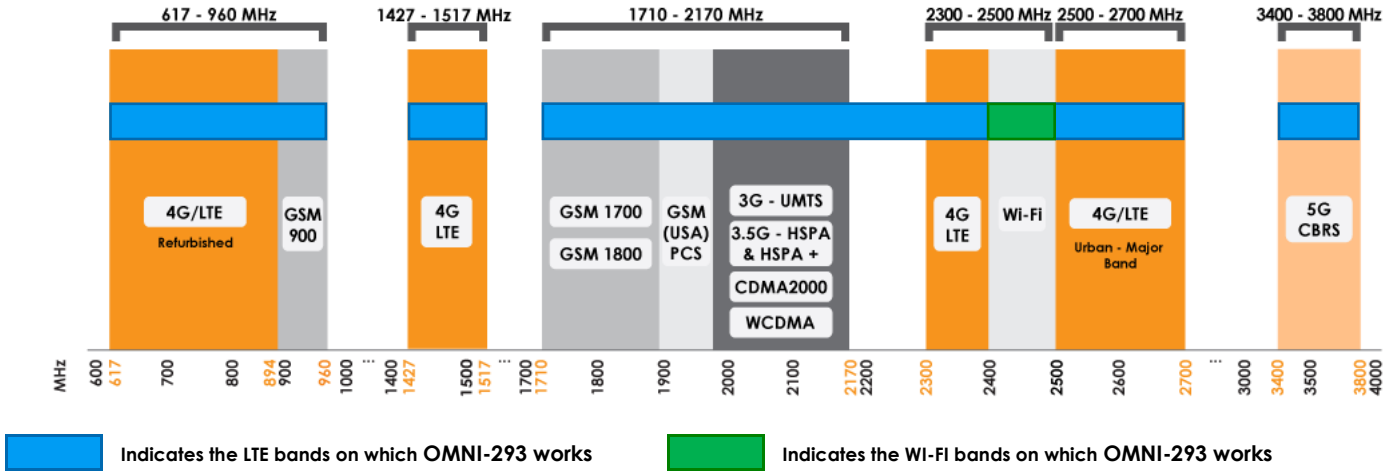

### Antenna Overview

Ports	1
SISO / MIMO	SISO
Frequency Bands	617 – 3800 MHz
Polarisation	Linear Vertical
Peak Gain	9 dBi
Coax Cable Type	N/A
Coax Cable Length	N/A
Connector Type	N-Type (F)

\*The connector is factory mounted to the antenna

## Electrical Specifications

<b>Frequency bands:</b>	617 – 960 MHz 1427 – 1517 MHz 1710 – 2700 MHz 3400 – 3800 MHz
<b>Gain (max):</b>	6 dBi @ 617 - 960 MHz 6 dBi @ 1427 - 1517 MHz 9 dBi @ 1710 – 2700 MHz 8 dBi @ 3400 -3800 MHz
<b>VSWR:</b>	<2.5:1 Over 90% of the bands

**Feed power handling:** 10 W

**Input impedance:** 50 Ohm (nominal)

**Polarisation:** Linear Vertical

**DC short:** Yes

## Product Box Contents

**Antenna:** A-OMNI-0293

**Mounting bracket:** Pole up to 50mm diameter  
Wall and pole mount stainless steel  
bracket

## Ordering Information

**Commercial name:** OMNI-293

**Order product code:** A-OMNI-0293-V1-01

**EAN number:** 6009710922347

## Mechanical Specifications

**Product dimensions:** 635 mm x Ø71 mm  
(excl. bracket)

**Packaged dimensions:** 700 mm x 95 mm x 90 mm

**Radome material:** ABS (Halogen Free)

**Radome colour:** Pantone - Cool Gray (1C)  
RAL - 7047

**Mounting Type:** Wall and pole mount

## Environmental Specifications, Certification & Approvals

**Wind Survival:** <160 km/h

**Temperature Range (Operating):** -40°C to +80°C

**Environmental Conditions:** Outdoor/Indoor

**Water ingress protection ratio/standard:** IP 65

**Salt Spray:** MIL-STD 810G/ASTM B117

**Operating Relative Humidity:** Up to 98%

**Storage Humidity:** 5% to 95% - non-condensing

**Storage Temperature:** -40°C to +70°C

**Enclosure Flammability Rating:** UL 94-HB

**Impact resistance:** IK 08

**Product Safety & Environmental:** Complies with CE and RoHS standards



**Antenna Performance Plots**

**VSWR**

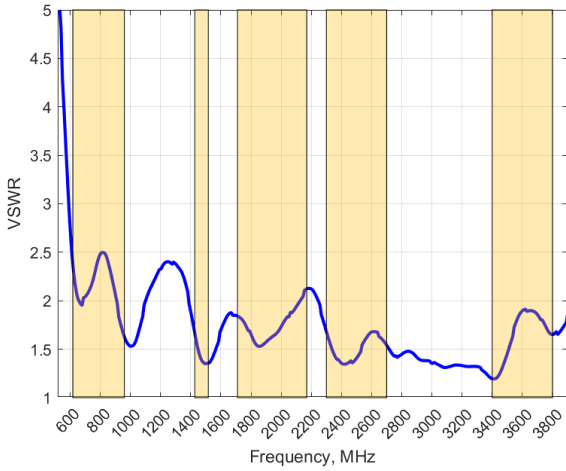

**GAIN (EXCLUDING CABLE LOSS)**

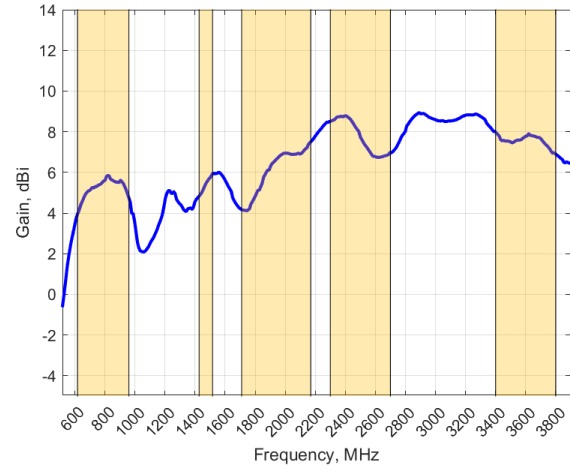

**Voltage Standing Wave Ratio (VSWR)**

VSWR is a measure of how efficiently radio-frequency power is transmitted from a power source, through a transmission line, into a load. In an ideal system, 100% of the energy is transmitted which corresponds to a VSWR of 1:1.

The OMNI-293 delivers superior performance across all bands with a VSWR of 2.5:1 or better over 90% of the bands.

*\*Antenna VSWR measured with no cable*

**Gain\* in dBi**

9 dBi is the peak gain across all bands from 617-3800 MHz

Gain @ 617 – 960 MHz:	6 dBi
Gain @ 1427 – 1517 MHz:	6 dBi
Gain @ 1710 – 2700 MHz:	9 dBi
Gain @ 3400 – 3800 MHz:	8 dBi

*\*Antenna gain measured with polarisation aligned standard antenna*

**Technical Drawings**

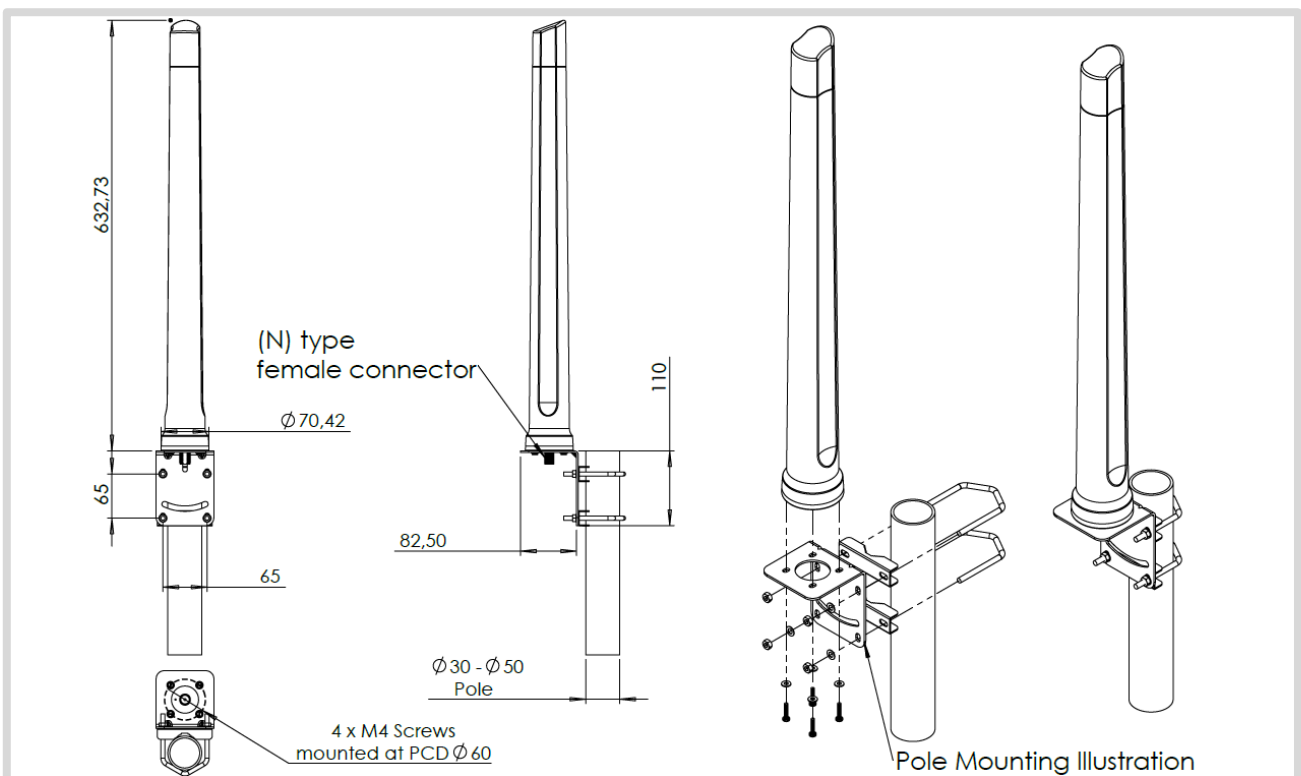

**Radiation Patterns**

Azimuth: 617 – 960 MHz      Azimuth: 1427 – 1517 MHz

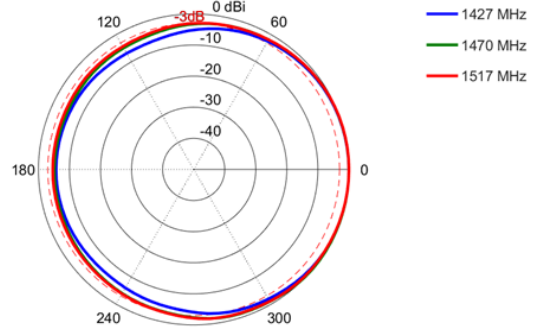
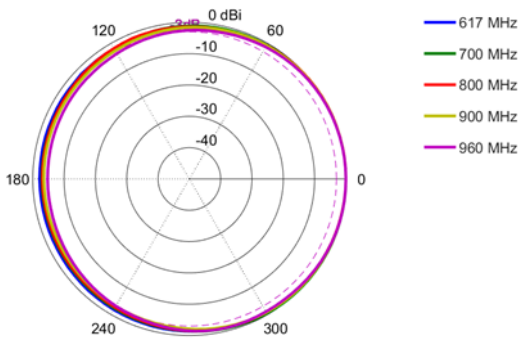

Azimuth: 1710 – 2170 MHz      Azimuth: 2300 – 2700 MHz

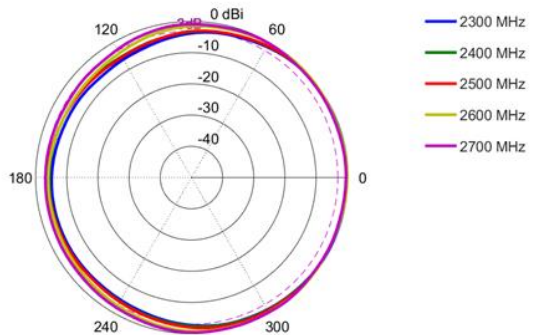
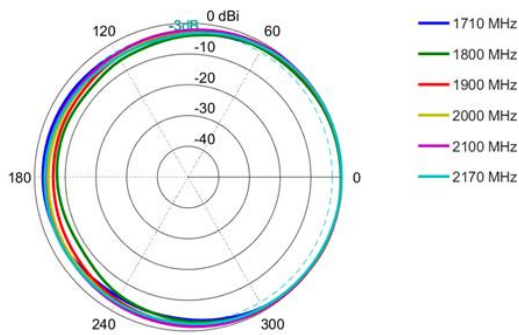

Azimuth: 3400 – 3800 MHz      Elevation: 617 – 960 MHz

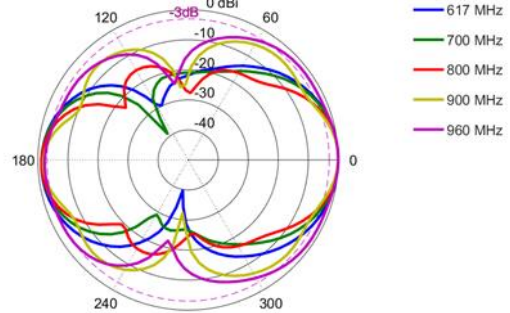
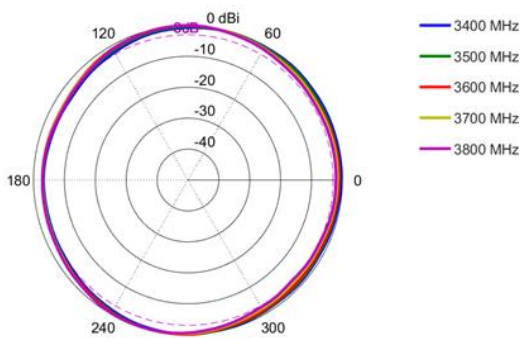

Elevation: 1427 – 1517 MHz      Elevation: 1710 – 2170 MHz

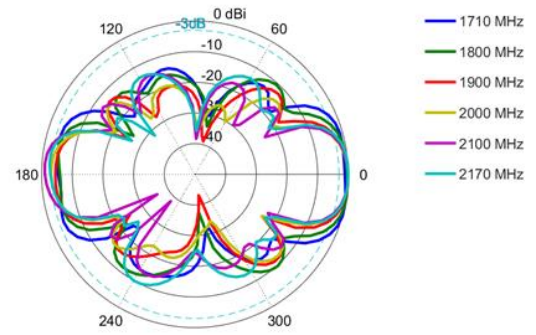
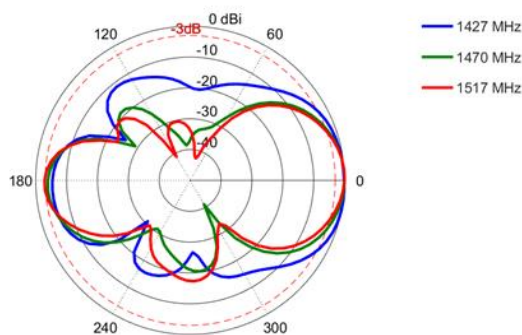

Elevation: 2300 – 2700 MHz | Elevation: 3400 – 3800 MHz

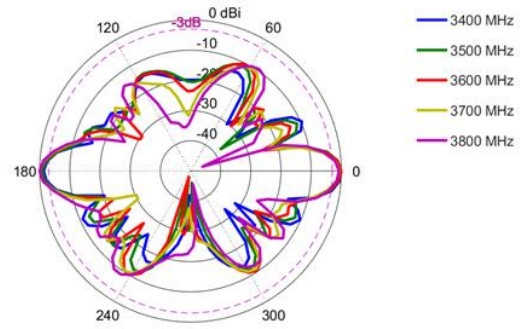
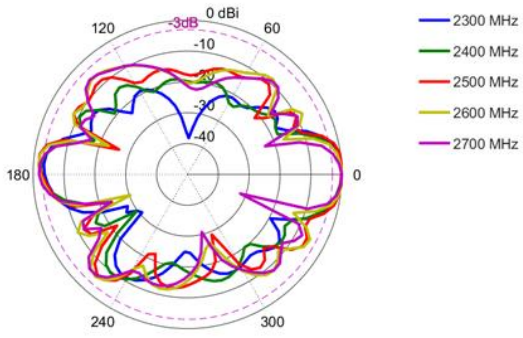

## Mounting Options

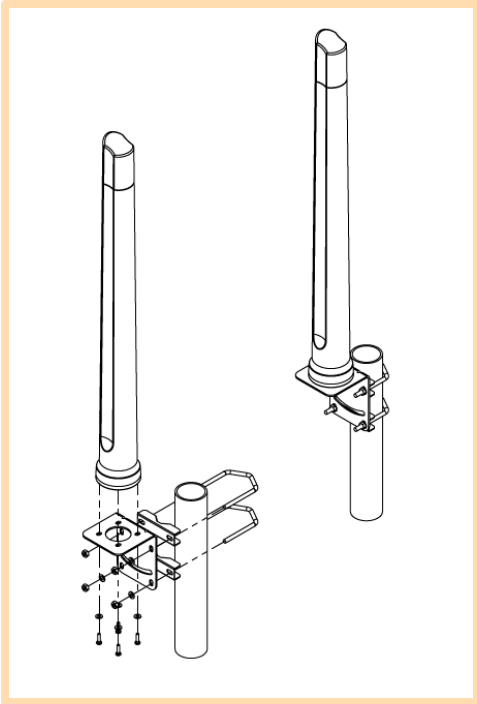

### Pole Mount

L-Bracket 316 Stainless Steel – included  
(for Ø 30-50mm pole)

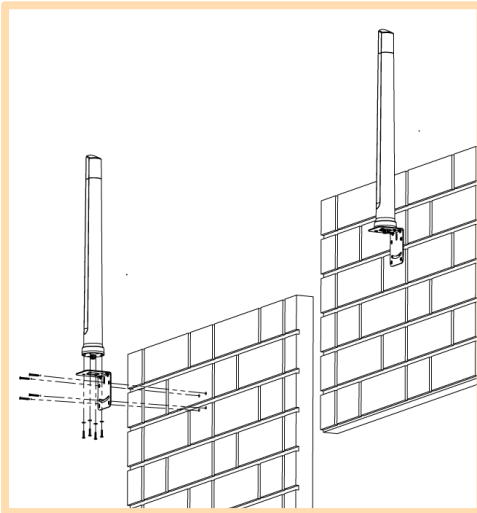

### Wall Mount

L-Bracket 316 Stainless Steel – included

---

## Additional Accessories

Extension Cables: Up to 15m HDF 195  
Various connectors available  
Installation poles and brackets available

See accessories technical specifications on [www.poynting.tech](http://www.poynting.tech)

---

## Contact Poynting

### Poynting Antennas (Pty) Ltd - Head Office

Unit 4, N1 Industrial Park  
Landmarks Avenue,  
Samrand, 0157  
South Africa

**Phone:** +27 (0) 12 657 0050

**E-mail:** [sales@poynting.co.za](mailto:sales@poynting.co.za)

### Poynting Europe

Regus Business Center Neue Messe Riem  
Kronstadter Straße 4  
81677 München  
Germany

**Phone:** +49 89 208026538

**E-mail:** [sales-europe@poynting.tech](mailto:sales-europe@poynting.tech)