

## ANTENNAS | OMNI-402 SERIES

# OMNI DIRECTIONAL MARINE ANTENNA

## HIGH PERFORMANCE 2X2 MIMO LINEAR MARINE & COASTAL 410MHZ – 2700MHZ ANTENNA

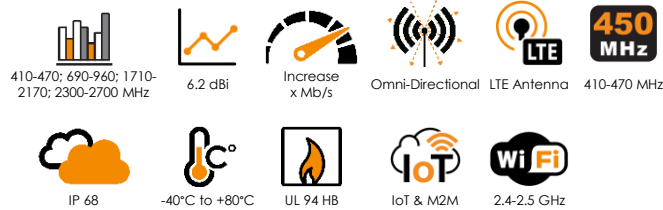

Urban



Rural/Farm



Marine

APPLICATION AREAS

- **2x2 MIMO Marine Quality High-Performance Omni Directional Antenna**
- **Easy mounting with feed through 1-inch marine standard adapter bracket included**
- **Robust and All-weather proof for harsh conditions at sea**
- **Various 316 Stainless Steel mounting brackets available optionally**
- **UV and Saltwater protected against tempestuous weather Conditions**
- **Protected against water and dust ingress, IP68**

### Product Overview

The OMNI-402 is an ultra-wide band antenna, which covers all contemporary LTE operating frequencies with excellent balanced gain across all frequencies, while providing 2x2 MIMO capability from its vertically separated radiating elements, all in the same radome. The antenna design allows the antenna to have superior pattern control over the entire frequency range making the OMNI-402 a true high performance omni-directional MIMO antenna, suitable for marine and coastal applications. Usable in all parts of the world, the OMNI-402 guarantees signal reception almost everywhere. Poynting Antennas achieves this through new antenna configuration using multiple dipoles and a unique (patented) feed network. The antenna is future proof as it covers the 450 MHz LTE frequency which is becoming more popular in various regions and countries!

### Features

- Medium gain omni-directional antenna
- The antenna is purpose-built for marine and coastal applications
- UV and Salt-water resistant
- Robust and weather resistant
- 2x2 MIMO
- 2.4 - 2.5 GHz band can be used as Wi-Fi antenna

### Application Areas

- Marine applications / Yachts / Boats / Ferries
- Enhanced LTE Reception
- IoT and M2M
- Poor data signal reception
- Improve data transmission connection reliability & stability
- Wi-Fi Applications



### Frequency bands

OMNI-402 is suitable for the following frequency bands | 410-470 MHz | 690-960 MHz | 1710-2170 MHz | 2300-2700 MHz |

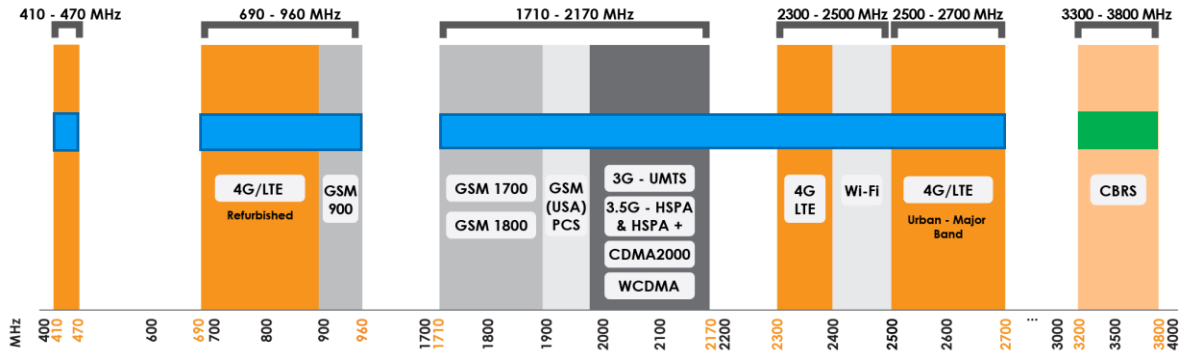

- Indicates the frequency bands which the OMNI-402 supports
- OMNI-402 supports the CBRS bands - not recommended for marine applications

### Antenna Overview

Frequency Bands	410 MHz - 2700 MHz
Peak Gain	6.2 dBi
Coax Cable Type	Twin Siamese HDF 195
Coax Cable Length	2m
Connector Type	2 x SMA male

### Technical Drawings

With Standard Marine Mounting:

With Standard L-Bracket Mounting:

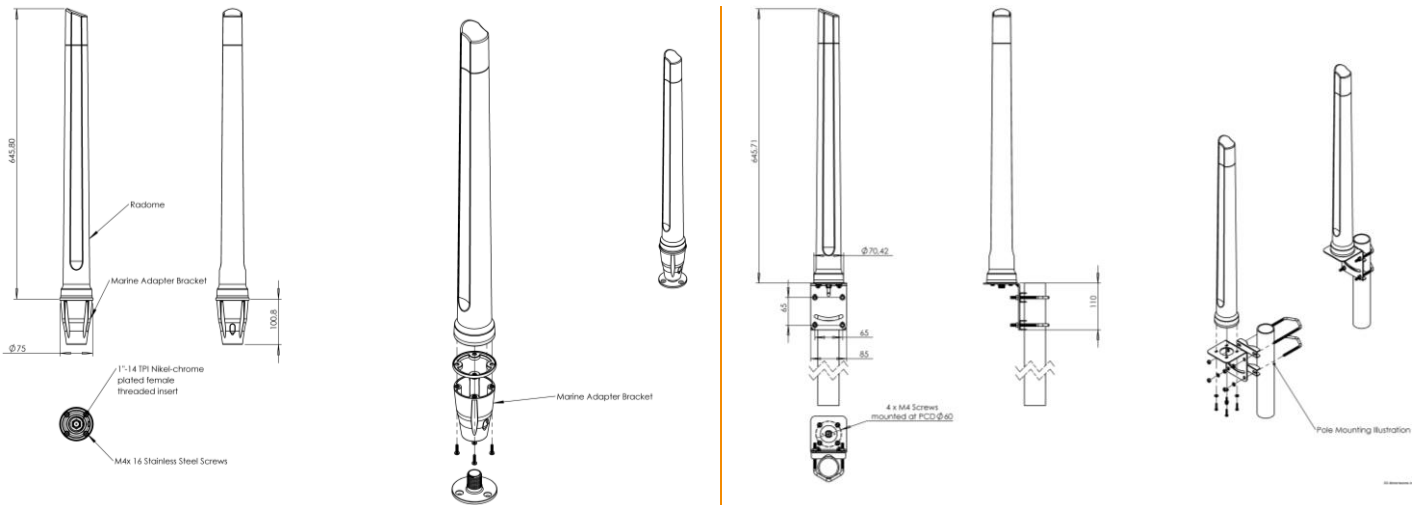

## Electrical Specifications

<b>Frequency bands:</b>	410-470 MHz 690-960 MHz 1710-2170 MHz 2300-2700 MHz
<b>Gain (max) Port 1 &amp; 2:</b>	6.2 dBi
<b>VSWR Port 1 &amp; 2:</b>	≤ 2.5:1 across 92% of the band
<b>Feed power handling:</b>	10 W
<b>Input impedance:</b>	50 Ohm (nominal)
<b>Polarisation:</b>	Linear Vertical
<b>Coax cable loss:</b>	0.35 dB/m @ 900 MHz 0.53 dB/m @ 2000 MHz 0.6 dB/m @ 2500 MHz 0.72 dB/m @ 3500 MHz
<b>DC short:</b>	Yes

## Coax Cable & Connector Type

<b>Cable length:</b>	2m
<b>Coax cable type:</b>	Twin Siamese HDF 195
<b>Connector type:</b>	2 x SMA male

*\*The coax cable and connector are factory mounted to the antenna*

## Product Box Contents

<b>Antenna:</b>	A-OMNI-0402
<b>Mounting bracket:</b>	Marine Adapter (1" -14 TPI) & L-bracket (Ø30-50mm Pole)

## Ordering Information

<b>Commercial name:</b>	OMNI-402
<b>Order product code:</b>	A-OMNI-0402-V1
<b>EAN number:</b>	0707273470393

## Mechanical Specifications

<b>Product dimensions</b>	± 750 mm x 75 mm (Incl. BRKT-40)
<b>Packaged dimensions:</b>	704 mm x 147 mm x 100 mm
<b>Weight:</b>	0,86 Kg
<b>Packaged weight:</b>	1,76 Kg
<b>Radome material:</b>	UV Stable SAN Marine ASA
<b>Radome colour:</b>	Brilliant White Pantone P 179-1 C
<b>Mounting Type:</b>	Standard 1" -14 TPI marine mount & Wall/pole mount

## Environmental Specifications, Certification & Approvals

<b>Wind Survival:</b>	<160 km/h
<b>Temperature Range (Operating):</b>	-40°C to +80°C
<b>Environmental Conditions:</b>	Outdoor/Indoor
<b>Water ingress protection ratio/standard:</b>	IP 68
<b>Salt Spray:</b>	MIL-STD 810F/ASTM B117
<b>Operating Relative Humidity:</b>	Up to 98%
<b>Storage Humidity:</b>	5% to 95% - non-condensing
<b>Storage Temperature:</b>	-40°C to +80°C
<b>Flammability Rating:</b>	UL 94-HB
<b>Impact resistance:</b>	IK 08
<b>Product Safety &amp; Environmental:</b>	Complies with CE, EN, CSA, RoHS and IEC standards



Antenna Performance Plots

VSWR

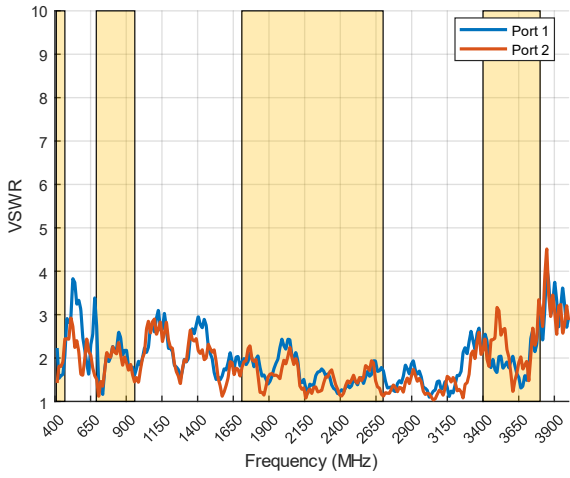

**Voltage Standing Wave Ratio (VSWR)\***

VSWR is a measure of how efficiently radio-frequency power is transmitted from a power source, through a transmission line, into a load. In an ideal system, 100% of the energy is transmitted which corresponds to a VSWR of 1:1.

The OMNI-402 delivers superior performance across all bands with a VSWR of <2.5:1 across 92% of the band.

\* Measured with 2m low loss cable

GAIN: (excluding cable loss)

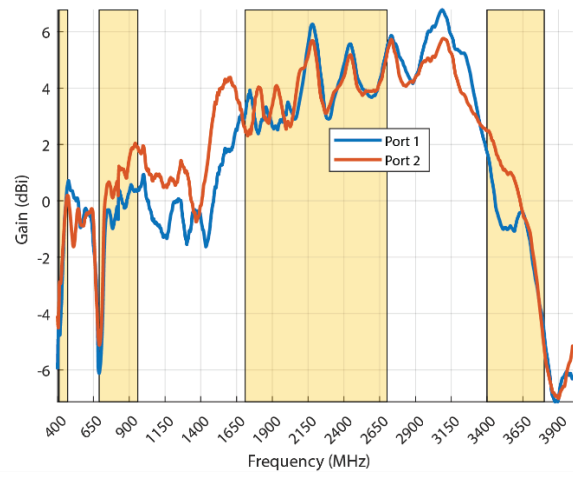

**Gain in dBi**

6.2 dBi is the peak gain across all bands from 410 – 2700 MHz

**Radiation Patterns (Ports 1 & 2)**

Azimuth (Top View): 410–470 MHz      Azimuth (Top View): 690–960 MHz      Azimuth (Top View): 1710–2100 MHz

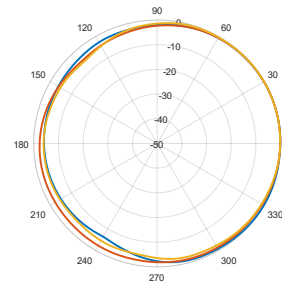
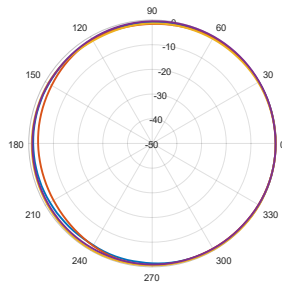
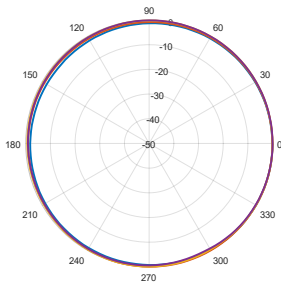

Azimuth (Top View): 2300–2700 MHz      Azimuth (Top View): 3400–3800 MHz      Elevation 1 (Side View): 410–470 MHz

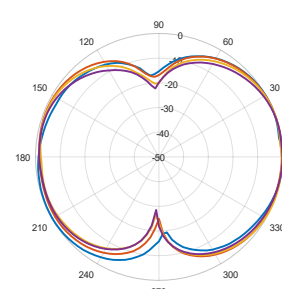
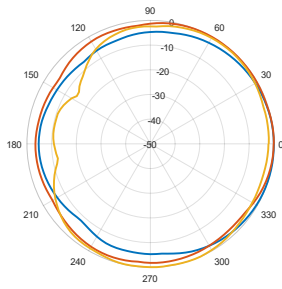
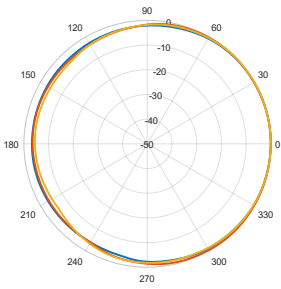

Elevation 1 (Side View): 690–960 MHz      Elevation 1 (Side View): 1710–2100 MHz      Elevation 1 (Side View): 2300–2700 MHz

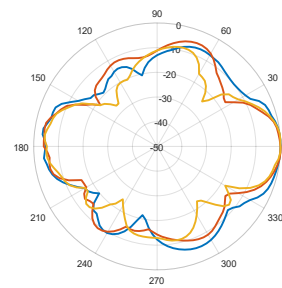
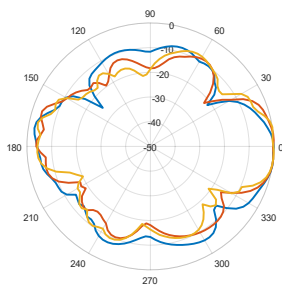
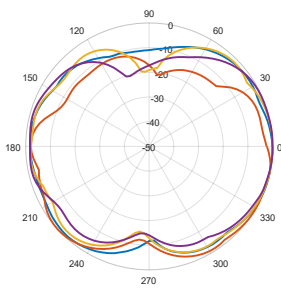

Elevation 1 (Side View): 3400–3800 MHz      Elevation 2 (Side View): 410–470 MHz      Elevation 2 (Side View): 690–960 MHz

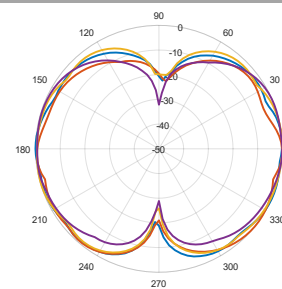
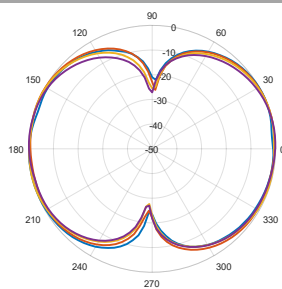
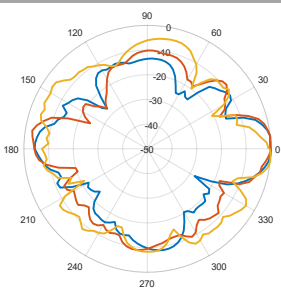

Elevation 2 (Side View): 1710–2100 MHz      Elevation 2 (Side View): 2300–2700 MHz      Elevation 2 (Side View): 3400–3800 MHz

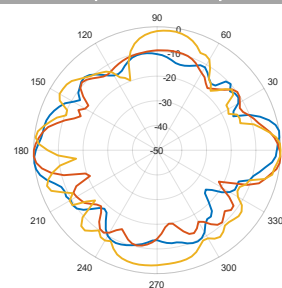
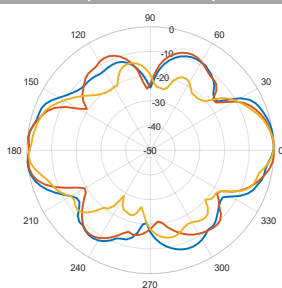
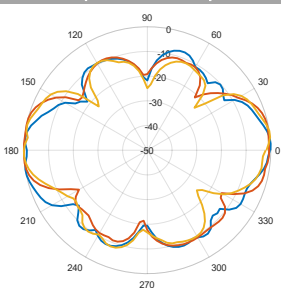

## Mounting Options

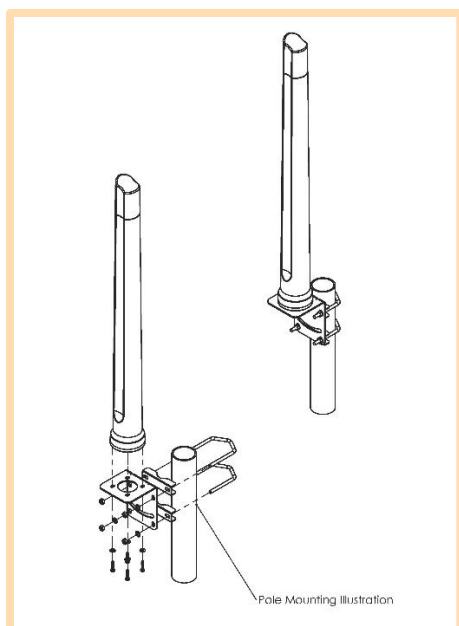

### Pole Mount

L-Bracket 316 Stainless Steel – included  
 (for Ø 30-50mm pole)

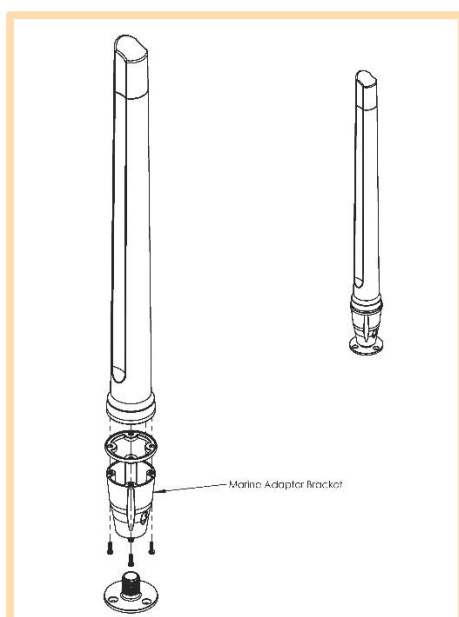

### Marine Bracket Mount

1" -14 TPI female adapter – included

Mounts to standard marine brackets:

- BRKT-37: Flat Mount - Optional
- BRKT-38: Ratchet Mount - Optional
- BRKT-39: Rail Mount - Optional

See Optional Accessories below

Also available: BRKT-41 with 1.25" – 11TPI female adapter (Optional)

See Accessories below

## Optional Accessories



### BRKT-37

Marine flat mount antenna bracket 1"-14TPI 316 Stainless Steel

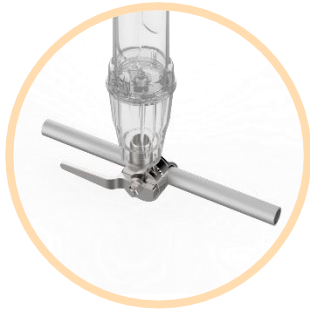

### BRKT-38

Marine ratchet rail mount antenna bracket 1"-14TPI 316 Stainless Steel



### BRKT-39

Heavy duty marine mount antenna bracket 1"-14TPI 316 Stainless Steel

See accessories technical specifications on [www.poynting.tech](http://www.poynting.tech)

## Contact Poynting

### Poynting Antennas (Pty) Ltd - Head Office

Unit 4, N1 Industrial Park  
Landmarks Avenue,  
Samrand, 0157  
South Africa

**Phone:** +27 (0) 12 657 0050

**E-mail:** [sales@poynting.co.za](mailto:sales@poynting.co.za)

### Poynting Europe

Regus Business Center Neue Messe Riem  
Kronstadter Straße 4  
81677 München  
Germany

**Phone:** +49 89 208026538

**E-mail:** [sales-europe@poynting.tech](mailto:sales-europe@poynting.tech)